

AO Research Institute Davos

Activity Report 2011

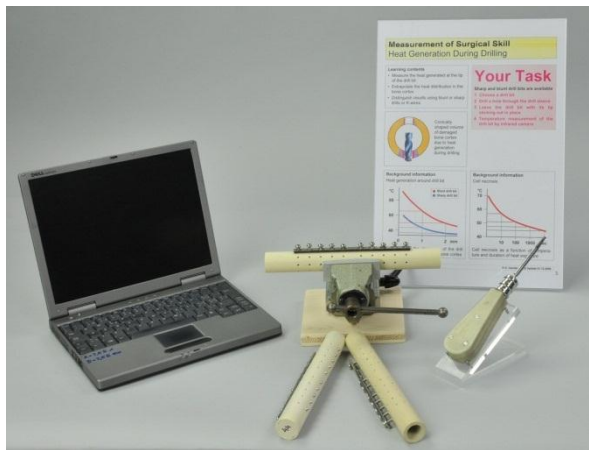

**RISystem AG**

Research implant systems with defined & reproducible biomechanics for studies

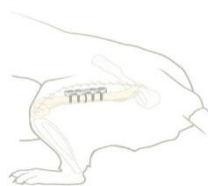

Locked micro plates

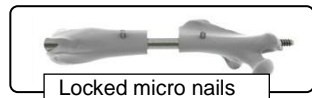

Locked micro nails

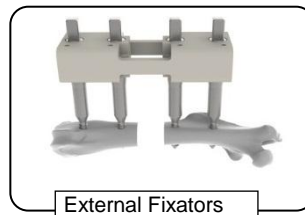

External Fixators

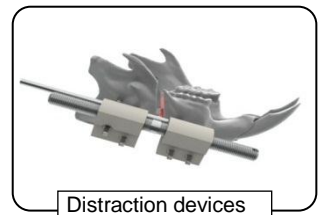

Distraction devices

# Table of contents

1. Introduction.....	3
2. Mission and Goals .....	4
3. Funding Summary.....	5
4. Programs, Groups and Focus Areas.....	6
5. Institutional and Professional Relations.....	21
6. Good News.....	22
7. eCM Journal and Conference.....	27
8. AO Research Institute Fellows .....	28
9. Project Abstracts by Specialties .....	31
10. Operations Standards and Safety.....	65
11. Team Members.....	66
12. Publications & Presentations.....	70



## 1. Introduction

Having been a member of ARI for over 20 years (September 1991 under the Directorship of Professor Stephan Perren), from a young postgraduate student to my position as the Director, I am proud to lead such a motivated and knowledgeable team of scientists which are well respected within the international musculoskeletal research field. The ARI team members (due to their large experience) sit on many international scientific committees for societies and congresses, reviewing, chairing sessions and giving invited keynote presentations. This collective knowledge can be used in many areas for the AO community, such as scientific guidance of young medical fellows, to course lectures on what a surgeon should know on various topics from bone healing, growth factors, infection, tissue engineering, biomechanics, osteoporosis, imaging modes to preclinical models.

While recently at the World Biomaterials conference in Chengdu China (the science capital of China, population of over 15 million), the personal translator assigned to me at one dinner mentioned that the table of Chinese dignitaries that I sat with knew of AO Davos as the place where trauma research comes from. One of the companies employing copyright or maybe the "right to copy" as they see it, displaying many of the products that had been studied and developed in ARI Davos from locking plates to angular stable nails immediately on seeing Davos on my badge knew I was from AO- the names AO Research and Davos are known together internationally.

I wish to note my gratitude to the ARI team members for their high dedication, hard work and motivation to both the AO Research Institute Davos and to the AO Foundation. Considering the difficult recent times in acquiring internal AO funding for the ARI from the numerous internal funding groups and the mass of administrative duties for the eight funding boards from whom we apply for this project money, the passion, driving energy and the outstanding research knowledge and skills of the ARI team members has still allowed real scientific progress for the benefit of the AO Foundation, as you will see in this report. I am also extremely happy to hear how motivated the Fellows are after their time they have spent with us to move forward within their careers wanting to be part of the AO Foundation. I wish to thank the specialty research commissions, AOERB board and members of the TK expert groups for their medical advice / guidance. I also would like to thank our CEO Rolf Jeker and our CFO/COO Lukas Kreienbühl for support and advice during the year.

In January 2011, twelve leading MIT researchers in USA noted in a white paper that convergence of disciplines is the future of medical research to give revolutionary advances in biomedicine. Convergence involves the merger of life, physical and engineering sciences – to foster the innovation necessary to meet the growing demand for accessible, affordable health care. The AO Research Institute Davos has been practicing convergence since 1959 working together on clinical problems through focused project goals with a multidisciplinary motivated research team of scientists, engineers, clinicians and veterinarians helping the revolution that the AO Foundation has brought to achieve more effective patient care worldwide. It is likely the credit of this idea will not be attributed to ARI though, as often happens with ideas from here.

Prof Dr R Geoff Richards, Director AO R&D

## 2. Mission and Goals

### Mission

Excellence in research and concept development within trauma and disorders of the musculoskeletal system and translation of this knowledge to achieve more effective patient care worldwide

### Goals within Mission

Contribute high quality research and concept development.

Investigate and improve the performance of surgical procedures, devices and substances.

Foster a close relationship with the AO medical community, academic societies, universities & industry.

Provide research environment / support for AO clinicians.



Prof R. Geoff Richards, ARI Director bringing the ARI achievements, goals and outlook to the Foundation Trustees at the 2011 trustee meeting in Berlin.



ARI management retreat, Filzbach with Dr Sebastian Wolf: To think does not mean to say; to say does not mean to be heard; to be heard does not mean to understand; to understand does not mean to agree; to agree does not mean to do; to do does not mean to keep doing – 2 days of intense thinking to improve our leadership skills.

### 3. Funding Summary

Income Statement	2010 Actual		2011 Actual	
	abs	%	abs	%
in CHF '000				
AO Foundation Contribution	7'768	71%	7'878	67%
3rd party Income	2'213	20%	2'960	25%
AO Intercompany	917	8%	994	8%
<b>Total Income</b>	<b>10'899</b>	<b>100%</b>	<b>11'833</b>	<b>100%</b>
AOTrauma *	2'793	26%	3'354	29%
AOSpine	601	6%	563	5%
AOCMF *	352	3%	460	4%
AOVET	57	1%	59	1%
AOTK	366	3%	400	4%
AOER *	2'900	27%	2'609	23%
AO Foundation *	1'355	13%	983	9%
3rd party projects	2'213	21%	2'960	26%
<b>Total Expenses</b>	<b>10'637</b>	<b>100%</b>	<b>11'388</b>	<b>100%</b>
<b>Net Result</b>	<b>262</b>		<b>445</b>	

\* incl. AO Intercompany

Compared to 2010 3rd party income increased by 33.75%.

GCTM CHF 895 K, Grants CHF 685 K, Subsidies CHF 440 K, other 3rd parties CHF 940 K

## 4. Programs, Groups and Focus Areas

### ARI Structure

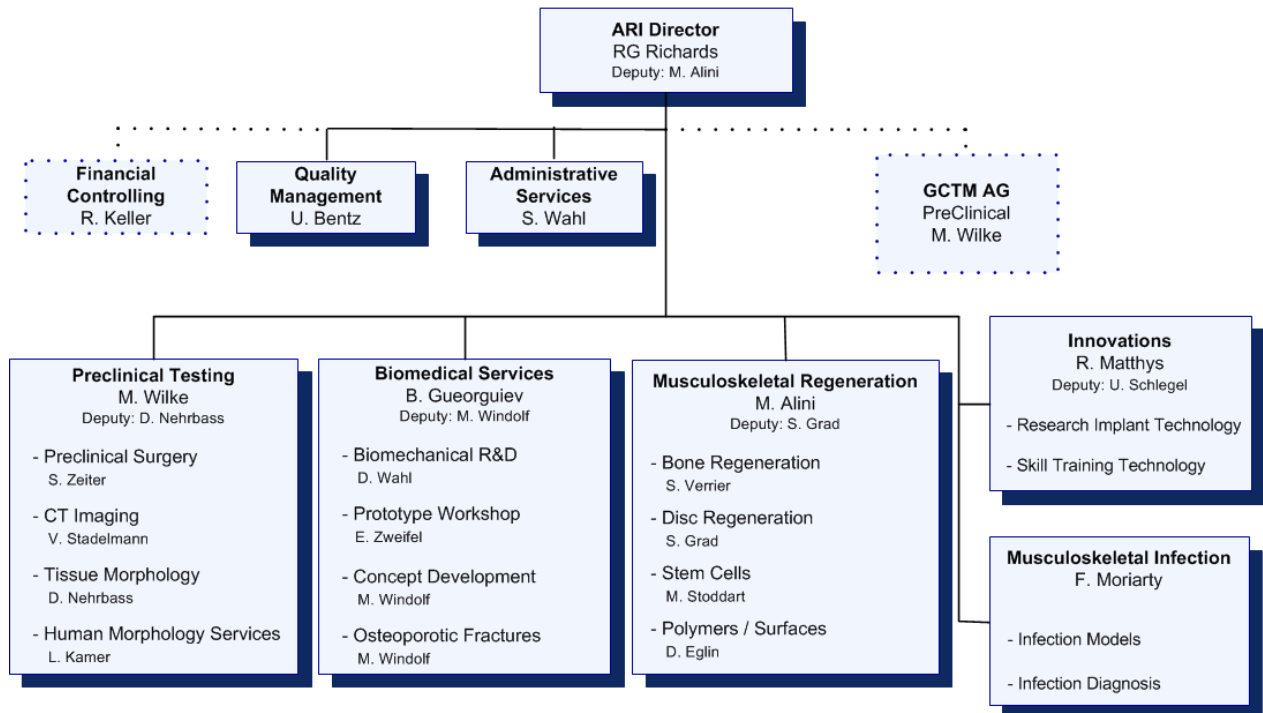

### Biomedical Services

Program Leader: Boyko Gueorguiev-Rüegg, Deputy: Markus Windolf

Team Members: Nando Adank, Yash Agarwal, Fabian Berri, Jan Caspar, Benno Dicht, Ladina Fliri, Matthias Forte, Kevin Frey, Priska Lemm, Stephan Rothstock, Ronald Schwyn, Dieter Wahl, Noel Wyss, Ivan Zderic, Erich Zweifel

Fellows: Ursula Eberli, Manuela Ernst, Mark Lenz, Albrecht Popp, An Sermon, Yasuyuki Shiozaki, Desislav Valchev, Ulf Viehöfer

The Biomedical Services Program performs research within the areas of Biomechanical Research, Concept Development, Osteoporotic Fractures and a Prototype Workshop. The focus areas are technically oriented and work in collaboration with scientific, clinical and industrial partners to improve patient care. The activities include biomechanical and finite element studies to investigate fracture fixation with special emphasis on osteoporotic bone conditions, development and analyses of new concepts and technologies of potential relevance to solve clinical problems.



## Biomechanical Research

The process of finding the optimal solution to clinical questions is enhanced by biomechanical modeling and testing, aiming to establish integrated experimental and computational investigation methods to support research in fracture fixation. The capabilities range from in silico methods to more classical anatomy within the new state-of-the-art anatomical wet labs (image above), where two workplaces are equipped with a radiolucent OR table, a C-arm and balanced LED operation room lights to mimic surgical conditions. A high resolution camera system, integrated into the OR light, is available for documentation and educational purposes. Advanced biomechanical studies are performed (image below), with material testing machines, using tailored testing protocols with physiological load patterns, supplemented with X-rays, video and inter-fragmentary motion tracking systems. Analyses based on finite elements methods help to design, optimize and test existing, as well as newly developed, implants on bone models.

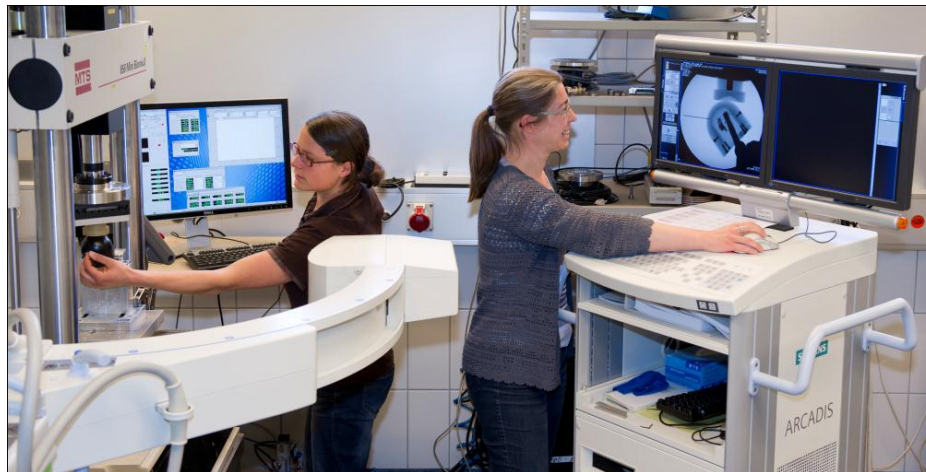

## Concept Development and Osteoporotic Fractures

Efficiency, simplicity and clinical relevance are directives to develop innovative solutions affecting musculoskeletal healthcare. With special reference to osteoporotic fractures, the team aims to improve various steps of operative fracture treatment involving advanced surgical decision making, simplified implant positioning, systematic implant optimization, reinforcement techniques with bone-cement and assessment of healing. The goals are pursued in strong cooperation with medical and technical collaborators worldwide in order to achieve the highest standards and requirements. From the idea to proof-of-concept; from proof-of-concept to a clinically applicable solution.

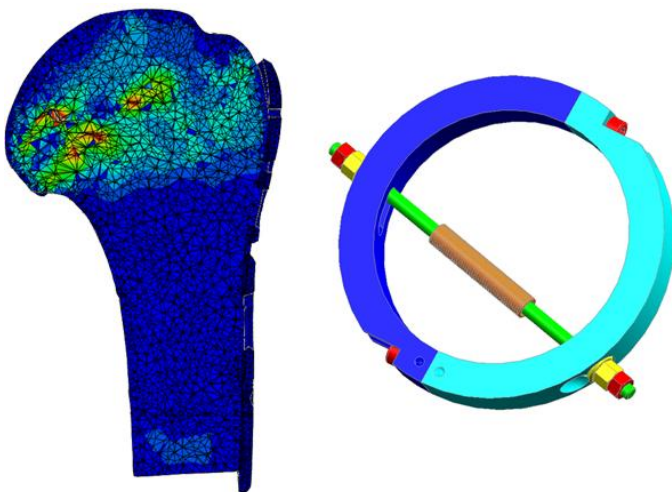

Numerical analysis for systematic implant optimization and novel fixation concepts with special reference to osteoporotic fractures.

## Prototype Workshop

In close collaboration with our project partners, the workshop is involved right from the beginning in developing of prototypes. It is specialized to facilitate the complete machining of sophisticated pieces, including milling, turning, wire cutting EDM and finishing. Highly trained CNC mechanics and toolmakers guarantee a high quality work and with precision.



Implants for research produced in the Prototype Workshop.



## Preclinical Services

Program Leader: Ludovic Boure (R Geoff Richards ai.)/Markus Wilke, Deputy: Dirk Nehrbass  
Team Members: Daniel Arens, Mauro Bluvol, Karin Camenisch, Andreas Catschegn, Iska Dresing, Peter Erb, Balazs Erdöhelyi, Pierina Faoro, Andrea Furter, Nora Goudsouzian, Thomas Heldstab, Lukas Kamer, Urban Lanker, Reto Müller, Angela Nehrbass, Hansrudi Noser, Dominic Perren, Stephan Zeiter, Damiano Schiuma, Monika Schneider, Sonam Sharma, Christoph Sprecher, Vincent Stadelmann, Sandra Thoeny  
Fellows: Stephan Arlt, Aswin Beck, Piyawan Chatuparisute, Yasushi Shinohara, Endre Varga, Florian Schmidutz, Balazs Bago

## Preclinical Facility

On March 8 2011 the first operation was performed in our new preclinical facility. Meanwhile building and installations have proven to function as planned. Day to day work such as patient handling have become less stressful for patients and more efficient for care takers and veterinarians who now reside in an open space office beside the housing facility. After a good start we are delighted to offer our services to internal and external customers in this state of the art facility.



## Preclinical Surgery Focus Area

Preclinical surgery has highly skilled and dedicated veterinarians, including ACVS (American College of Veterinary Surgeons) / ECVS (European College of Veterinary Surgeons) diplomates, European College of Laboratory Animal Medicine (ECLAM) and European College of Veterinary Anesthesia and Analgesia (ECVAA) residents, scientists and technical staff. The combined knowledge and experience is utilized to develop models, plan experiments, conduct studies, analyze data and prepare study reports along with Best practice in animal care. Preclinical Surgery has gained an extensive experience with different models for musculoskeletal research over decades. There is a variety of standardized and well characterized models (critical and non-critical sized bone defects, cartilage defects and tissue response to biomaterials) available for research. Novel models can be developed. The surgery facility was updated with completion in January 2011 with modern operation rooms (2), a preop patient preparation room, sterilization area and state of the art equipment as used in clinics).

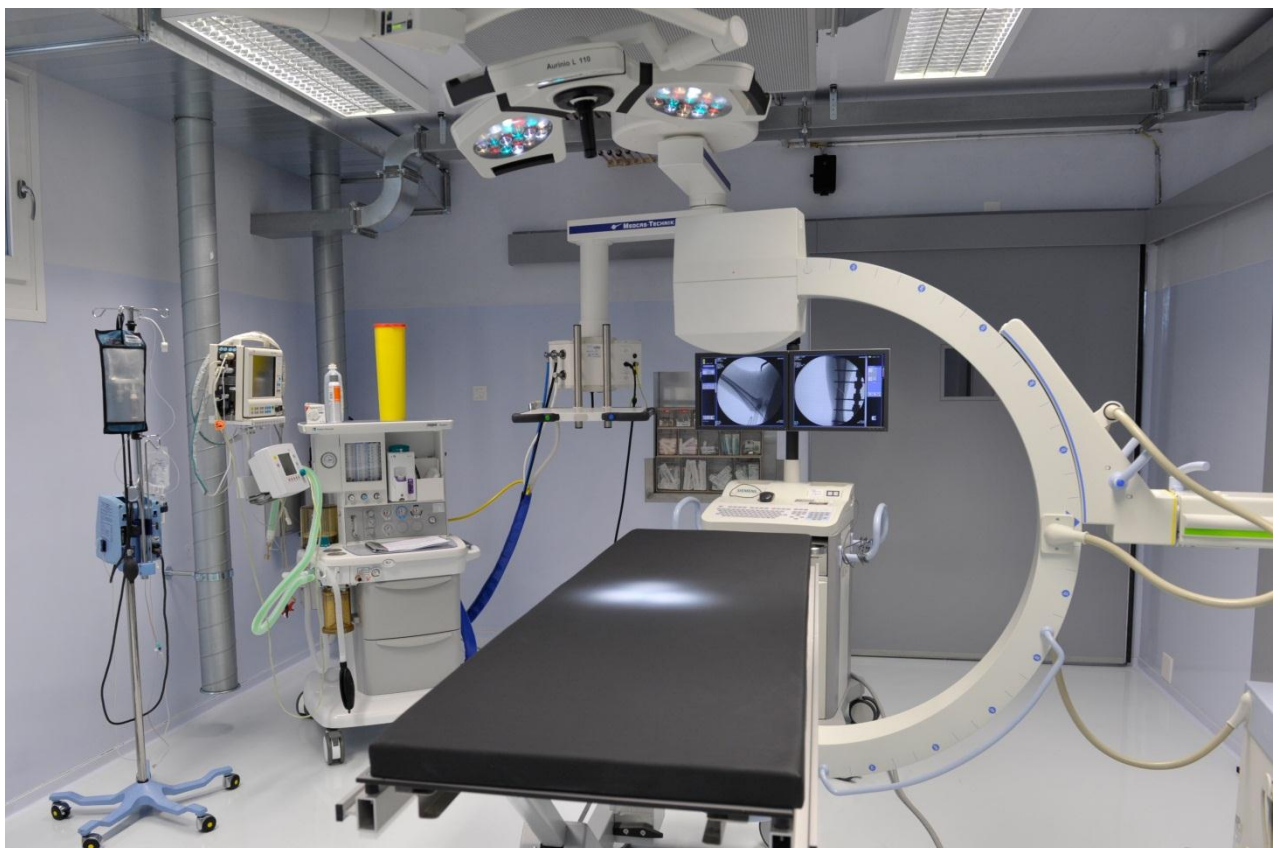

## CT Imaging Focus Area

The Imaging Focus Area is an interdisciplinary team (physicist, biomechanic and bioengineer). The focus of our team is to investigate bone quality, bone healing and implant anchorage by means of computed tomography. Our daily work involves the design of image acquisition routines, development of custom image processing algorithms, and management of large image databases.

Our core competence is Computed Tomography (CT). CT produces 3D data that can be manipulated in order to visualize various bodily structures based on their ability to block the X-ray beam. Our clinical CT allows us to work with large animal models in-vivo. The XtremeCT and VivaCT allow us to scan small animals in-vivo and in-vitro specimens at very high resolution, and to analyze the finest details of their bony structures.

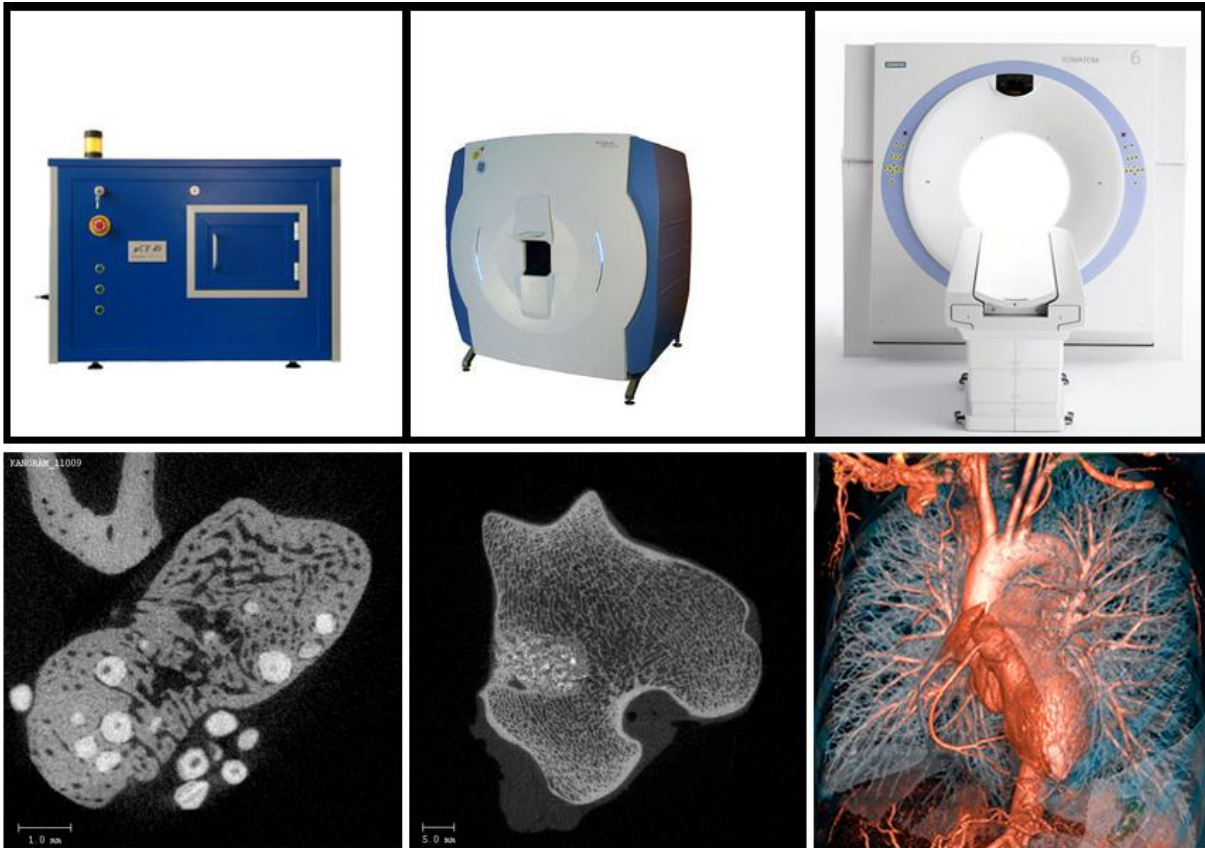

CT FACILITY: (Left) With resolution of 6 $\mu$ m MicroCT is used to analyze very small structural features. (Center) XtremeCT is used to analyze Human bones at a resolution of 82 $\mu$ m. (Right) With a very high contrast power, the clinical CT is used to analyze various anatomical features

## Human Morphology Services Focus Area

The area bridges the gap between imaging and surgery. Human Morphology Services supports in topics related to medical image processing & analysis. It forms an interdisciplinary team with competences in computer science, computer-aided design, medicine, dentistry and physics. The services comprise a comprehensive infrastructure to run and maintain a database of computed tomography (CT) scans, three-dimensional (3D) virtual bone models and 3D statistical bone models. The virtual data enhances the reliability of 3D bone models and their assessment and optimizes the efficiency and quality of projects. Aside from collecting data, a main task arises from developing adequate techniques and workflows to analyze any other medical image data.

### R&D focus Medical Image Processing & Analysis

- database of CT scans, 3D bone models and 3D statistical bone models
- CT anatomy / CT based morphological studies
- enhanced 3D visualizations of medical image data
- CT based 3D fracture analysis
- computerized preoperative planning (concept development)
- 3D patient assessment / 3D control of surgical outcome
- development of R&D software tools

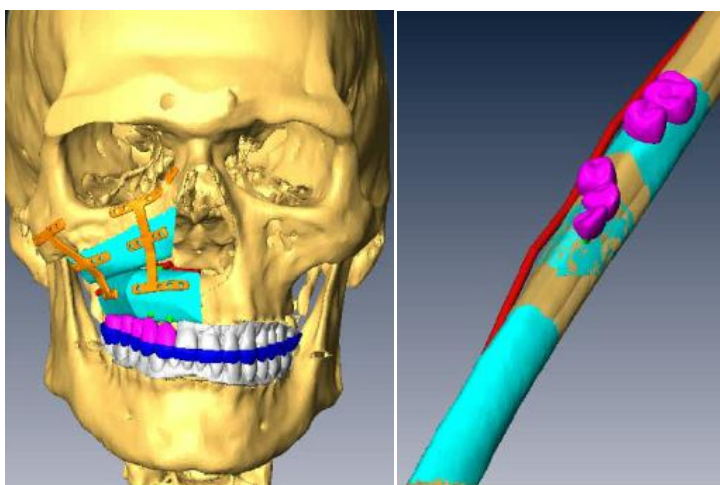
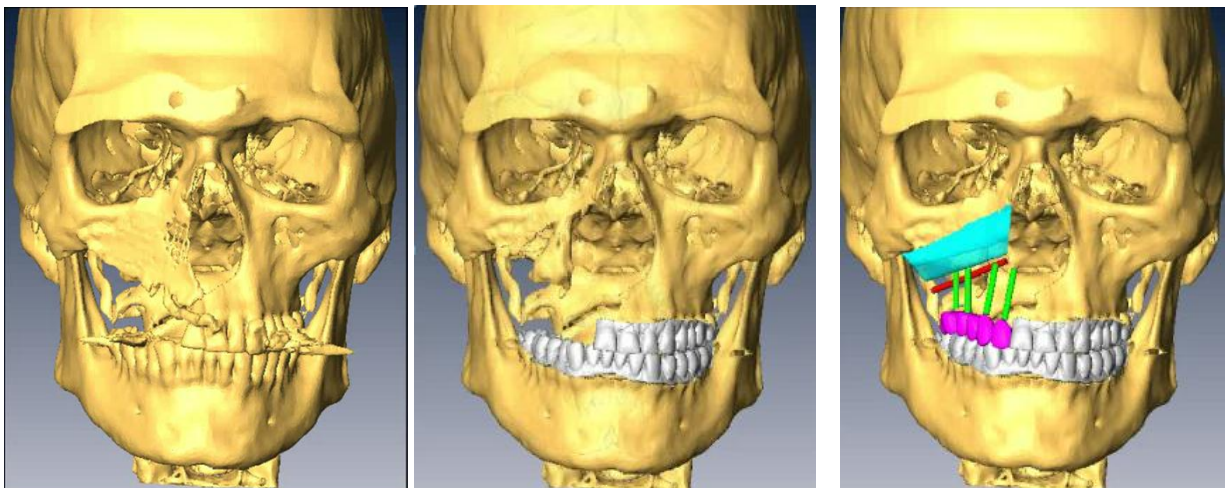

Computerized workflow for the reconstruction of large sized maxillofacial defects, elaborated together with the expert surgeon. All important key features like planning of the dental occlusion, dental implants, size and shape of the bone grafts with their blood supply may be simultaneously evaluated at both, the graft harvesting (fibula) and the recipient site. Computer-aided designed and manufactured (CAD/CAM) reconstruction plates act as an accurate intraoperative guidance and fixation device.

## Tissue Morphology Focus Area

Tissue Morphology provides collaborative research and services, which include histology of paraffin-embedded, cryofixed, and non-routine resin-embedded undecalcified hard tissue, with and without implants. For immunohistochemistry and cytochemistry, we have standard protocols for several different techniques. Microscopic investigations including image analysis can be performed using conventional transmitted and several reflected light methods including fluorescence and confocal microscopy. Surface topographical characterization can be performed with white light profilometry, scanning electron microscopy (SEM) is available for use in material morphological analysis as well as routine elemental determination using energy dispersive X-ray microanalysis (EDX). State of the art SEM techniques have been developed internally for biomaterial, cell, tissue and bacterial interface studies.

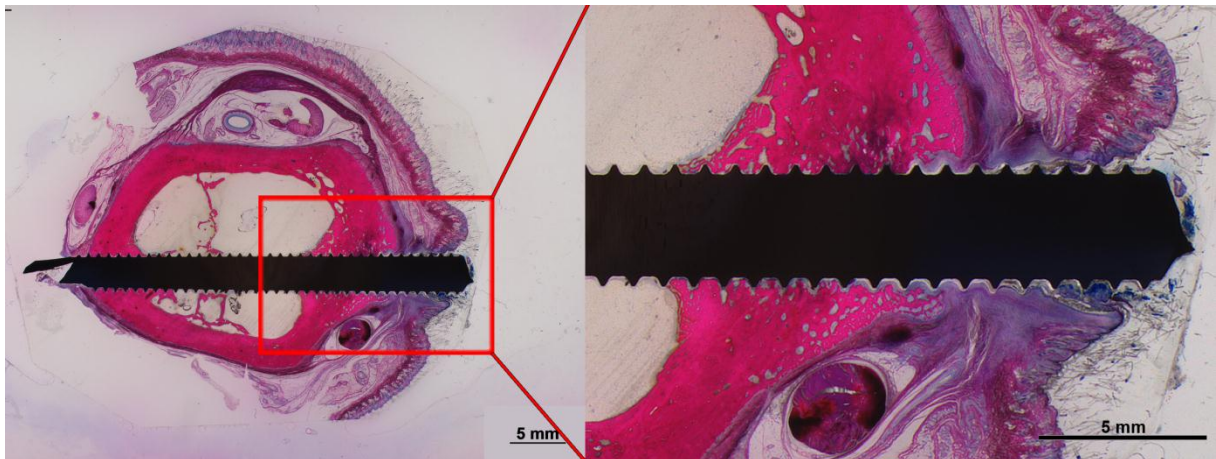

Histological section of undecalcified bone (sheep tibia) with a stainless steel Schanz screw – note on the high magnification (right side) the large degree of close bone contact to the screw, the minimal callus formation, and the minimal formation of subcutaneous granulation tissue without pronounced signs of inflammation.

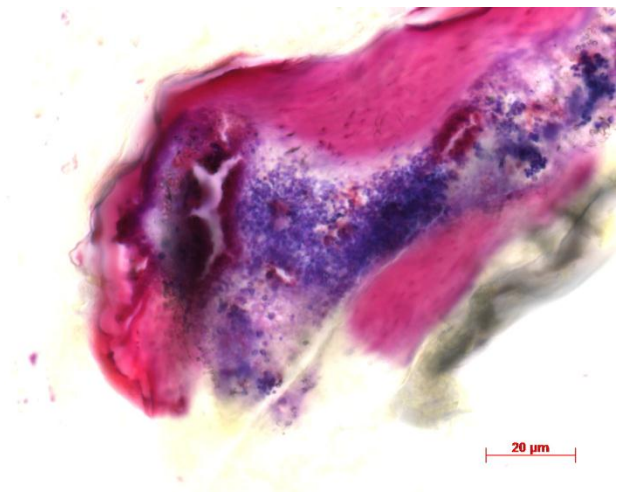
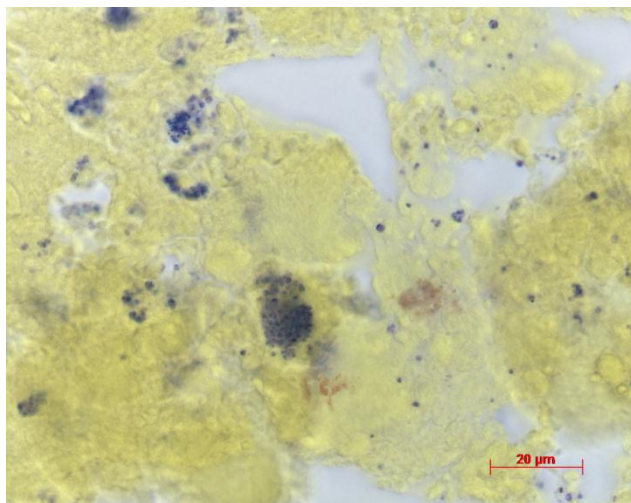

Left: Induced infection in a rabbit, numerous coccoid bacterial colonies in the bone marrow (proximal tibial abscess). Right Spontaneous infection of a sheep inside of the trabecula of cortical bone (tibial shaft beside implant).

## Musculoskeletal Regeneration Program

Program Leader: Mauro Alini, Deputy: Sibylle Grad

Team Members: Marco Bruderer, Ewa Czekanska, Sandrine Egli, David Eglin, Matteo D'Este Markus Glamer, Patrick Lezuo, Zhen Li, Ursula Menzel, Alexander Neumann, Girish Pattappa, Marianna Peroglio, Robert Peter, Alexandra Poulsson, Martin Stoddart, Abby Sukarto, Patrick Trüssel, Sophie Verrier

Fellows: Oliver Schätti, Nadine Wismer, Domimik Wolf, Marios Petrou, Julian Ergelet, Judith Staudacher, Tobias Reuber, Fabian Duttenhöfer, Rafael Lara de Freitas, Britta Striegl

Guests: Ryan Seelbach, Giuseppe Musumeci, David Larroze, Fabrizio Russo, Gian-Luca Vadala, Estelle Collin

The program develops biological approaches addressing pathologies of the musculoskeletal system, with a particular focus on bone, disc and cartilage tissues. The ultimate goal is to define strategies for prevention of skeletal degenerative disorders and to re-establish functionality.



Cell culture laboratory of the program

## Bone regeneration Focus Area

Critical size bone defects are defined as those being more than 1.5 times larger than the bone diameter and do not heal if left untreated. This constitutes a major challenge for trauma surgeons. In this focus field, we aim to develop biological substitute, capable of mimicking the natural environment, and to regenerate and improve the functional state of damaged tissue.

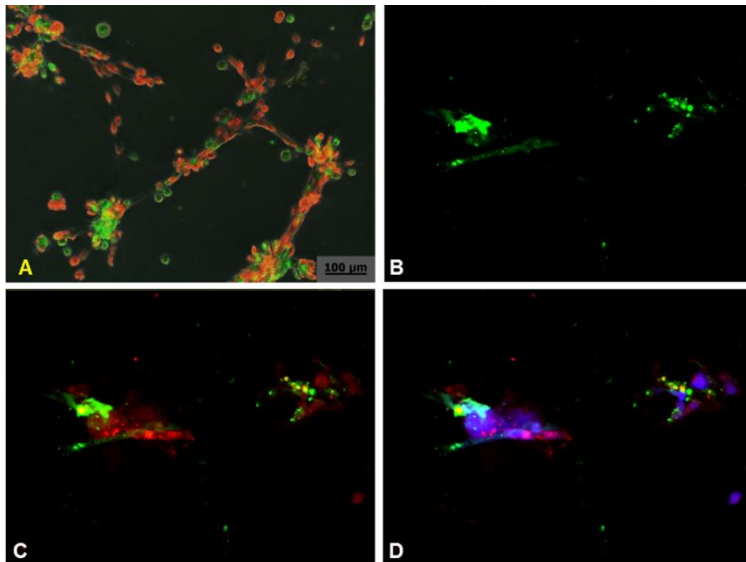

Endothelial progenitor cells (EPC) and bone marrow mesenchymal stem cells (MSC) 2D co-culture. EPC are stained with PKH67-green® (A, B). MSC are labeled with PKH26-red® (A, C, D). After 4 hours, co-cultures showed the presence of cellular network involving both cell types (A, C). Using CD146 immunolabelling (blue color), merged picture (D) showed co-localization of the CD146 pericyte-marker with MSC.

## Disc repair/regeneration Focus Area

Present surgical approaches to intervertebral disc (IVD) repair are still unsatisfactory. Biological approaches, including the application of cells, anabolic factors and/or biomaterials, offer potential. We have designed and developed a whole organ IVD culture system with the ability to maintain entire discs with endplates under controlled nutrition and loading conditions. Using this bioreactor the effects of nutrients and of defined mechanical forces on endogenous cell viability and metabolic activity can be investigated. Furthermore, the potential of novel biological treatment strategies and endogenous cell activation can be evaluated. The ultimate goal is to develop a functional system which will, upon implantation, provide immediate closure of an annular defect and maintain the mechanical properties of the disc, while the cellular component will enhance the endogenous regenerative process.

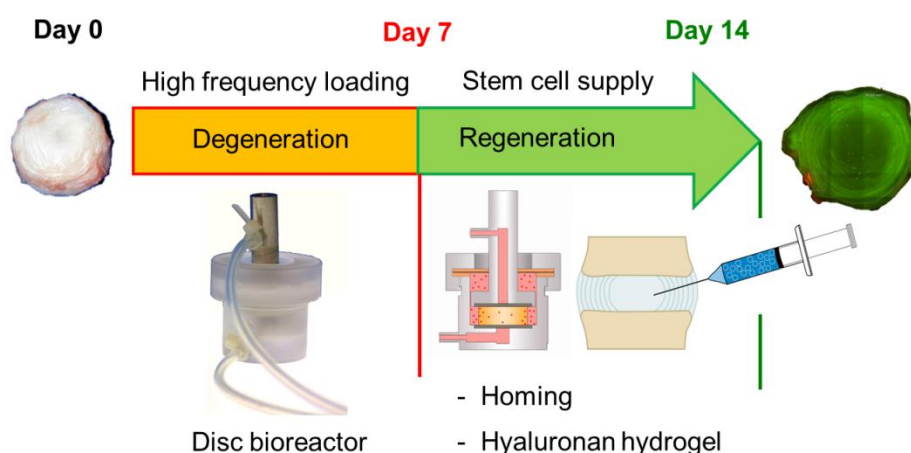

Whole organ intervertebral disc culture concept for simulating disc degenerative processes and testing regenerative and repair strategies ex vivo. Approaches for stem cell therapy include (i) cell homing induced by chemotactic factors and (ii) cell injection using a thermoresponsive hyaluronan-based hydrogel as cell carrier.

## Stem cell Focus Area

The area aims to investigate the role of mechanical and soluble factors in the promotion of differentiation and tissue repair. The focus area investigates methods by which stem cell therapies for bone and cartilage could be applied within a clinical setting. One example of this would be investigating the role of various mechanical factors on human mesenchymal stem cell (MSC) differentiation. Using a custom built bioreactor which is able to apply compression, shear or a combination of both forces, we were able to determine that shear, superimposed on compression, is critical when inducing chondrogenesis in the absence of externally applied growth factors. This knowledge could be utilized in order to optimize rehabilitation protocols after MSC cell therapy for cartilage defects or intra-articular fractures.

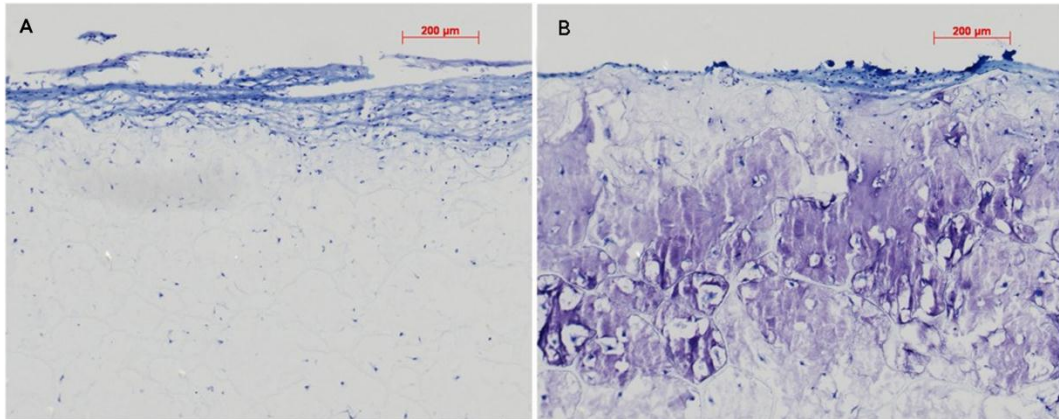

Human bone marrow derived stem cells were subjected to A) uniaxial or B) multiaxial load in the absence of growth factors. Only multiaxial load was capable of driving the cells towards the endochondral pathway, as can be seen from the purple staining glycosaminoglycan.

## Polymers and Surfaces Focus Area

Polymer matrices for skeletal repair must be fabricated to deliver cells and biological factors, create potential space for tissue development, and guide the process of tissue regeneration. One goal is the development of highly porous 3D structures for bone and cartilage tissue engineering, using tailored polymers and composites. Our experience lies in the design of biocompatible, biodegradable polyurethanes and their processing with controlled architecture. A second field of research investigates thermoresponsive semi-natural hydrogels prepared from hyaluronic acid and poly (N-isopropyl-acrylamide) using a 'click chemistry' reaction. These injectable biodegradable materials have massive potential for medical applications, e.g. delivering cells, drugs, and biological signals to the tissues. Creating an optimal surface is crucial for polymers and may imply reducing the surface energy, e.g. to reduce tissue build-up, or increasing the surface energy to aid tissue integration for orthopedic applications such as polyetheretherketone (PEEK) spine cages and craniomaxillofacial implants.

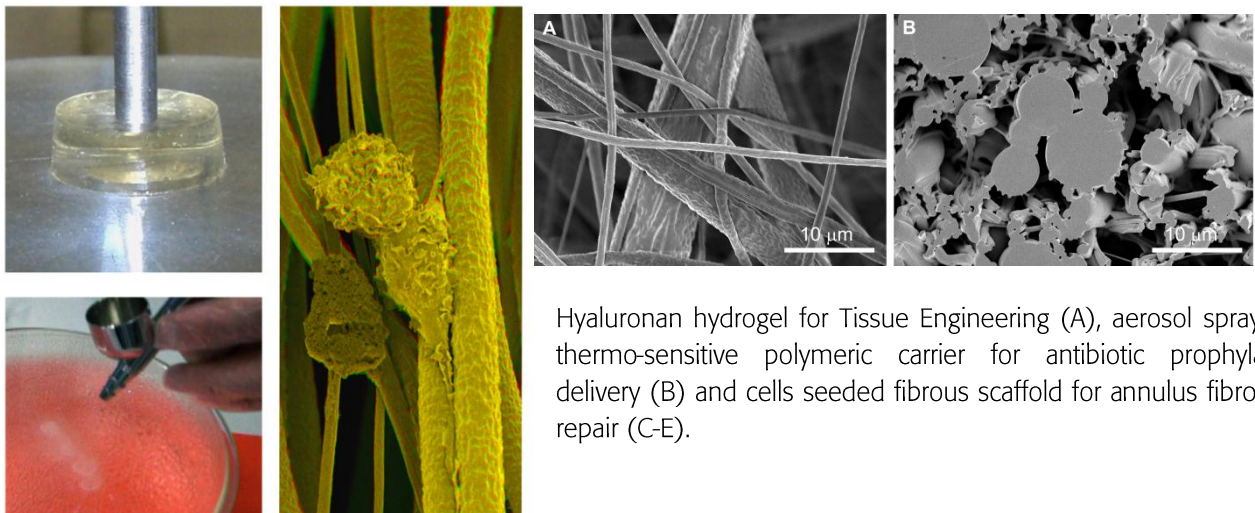

Hyaluronan hydrogel for Tissue Engineering (A), aerosol spray of thermo-sensitive polymeric carrier for antibiotic prophylaxis delivery (B) and cells seeded fibrous scaffold for annulus fibrosus repair (C-E).



## Musculoskeletal Infection Group

Group Leader: Fintan Moriarty

Team Members: Edward Rochford, Inga Potapova, Virginia Post, Iris Keller, Pamela Furlong

Fellows: Lorenzo Calabro, Hayder AlSaadi, Abhay Gahukamble, Julian Salavarietta, Claus Seyboth

Guests: Marina Turalija

The team performs research to develop improved models of infection and laboratory based research into biomaterials with a focus on infection and novel strategies for diagnosis of infection. The group moved into their new laboratories in 2011 amongst the spaces vacated in the relocation of the preclinical facility.

Goal 1: Much research has been focused on ways to further reduce the incidence of infection associated with fracture fixation devices, such as basic design modifications or antibiotic loaded coatings. In the Musculoskeletal Infection group we aim to develop clinically relevant standardized preclinical models of infection that may be used to test the performance of any such new implant design or active coating.

Goal 2: Infections associated with implanted fracture fixation devices can be difficult to diagnose. This is because the clinical presentation of the infections may be subtle and similar to sterile inflammation, delayed healing or aseptic non-unions. The development of new infection-specific diagnostic tools is the second goal of the musculoskeletal Infection.

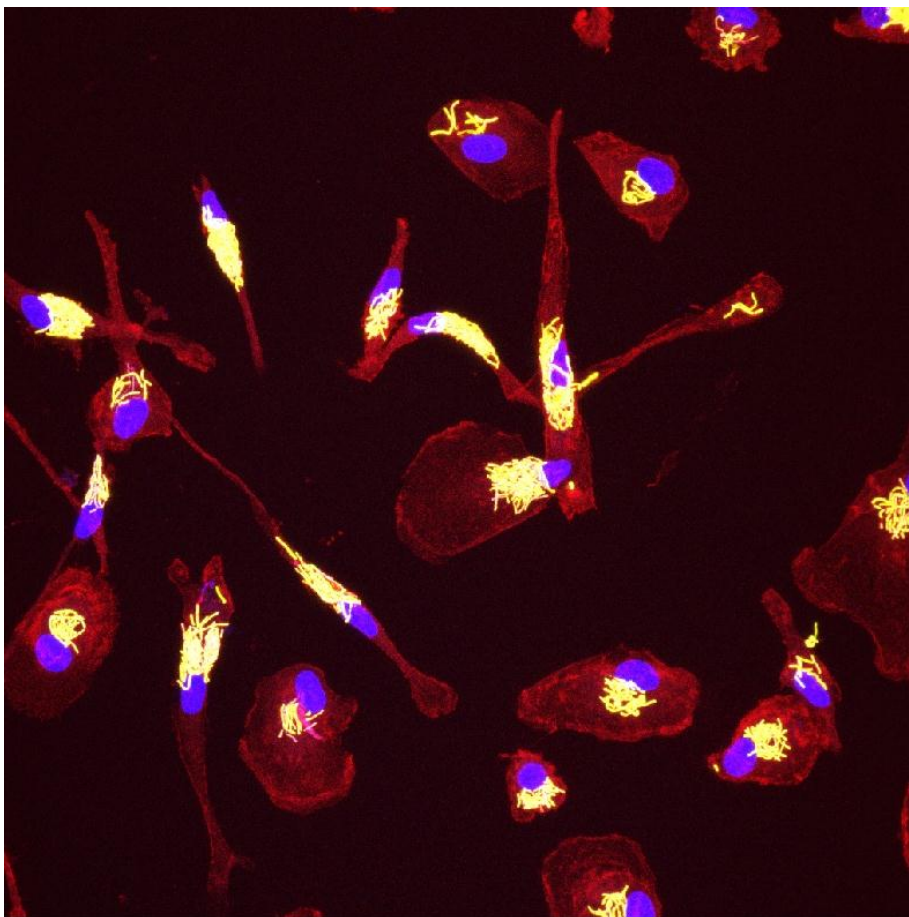

Phagocytosis of contaminating bacteria by cells of the adaptive immune response

## Innovations Group

Group Leader: Romano Matthys

Team Members: Urs Schlegel, Peter Däscher, Reto Nützi, Dieter Wahl

Fellow: Sandra Wissing

In late autumn 2010 the AO agreed to the request from Romano Matthys to create a spin off from the focus area "research technology" of the Innovations group into a separate new company. Approximately one year later the company RISystem AG was founded by the AO Technology AG (49%) and Romano Matthys (51%). Two former ARI coworkers, Reto Nützi and Romano Matthys, left the ARI by end of 2011 and started with the new challenge under RISystem AG in January 2012 in Davos.

The other very successful focus area from Romano "Skill training technology" with two core projects the "PlayGround for trauma surgeons" and the "Oskit" (a reusable fracture fixation learning box based on the Müller Classification) were handed over in the value chain to AO Education. The handover included infrastructure, stock and technical support personnel Urs Schlegel and Peter Däscher to form "Skill training and Simulations group" of AO Education under the lead of Michael Redies. The remaining member of the team Dieter Wahl, rejoined Biomedical Services as a senior project leader with a high amount of experience within this area. The Innovations Group was therefore dissolved at the end of 2011 and its responsibilities in concept development continued under Markus Windolf in the Concept Development Focus area of Biomedical Services.



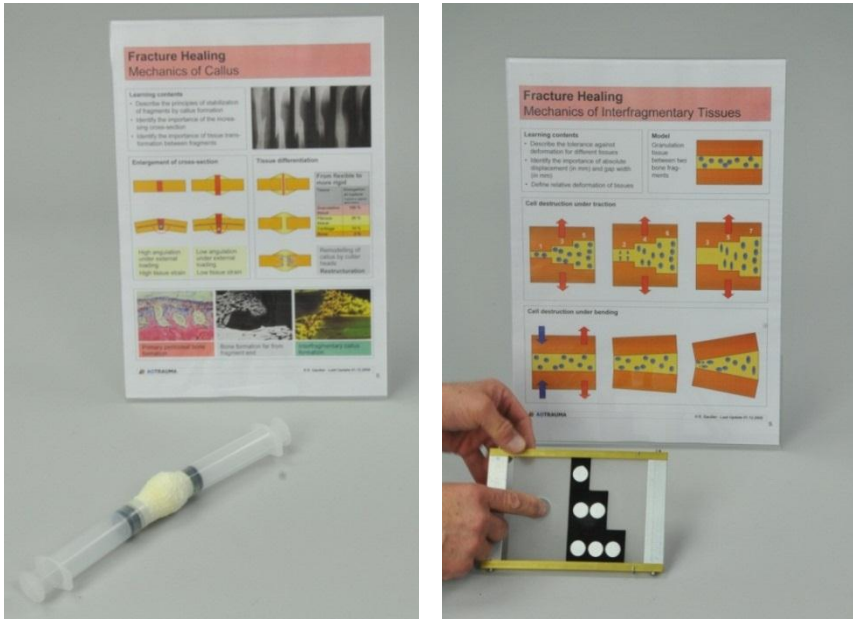

Fracture healing station from the playground developed in ARI.



Peter Däscher (above) and Urs Schlegel (below) who left ARI at the end of 2011 to join AO Education with the developed Playground. The move from ARI to Education should help wider teaching to residents, surgeons and ORP in a face-to-face approach with technical support from Peter and Urs in the problem related teaching modules.



## ARI Administrative Services Group

Manager: Sonia Wahl

Q-Manager & Purchasing: Ulrich Bentz

Team Members: Nadine Abegglen, Claudia Barblan, Carla Escher, Tanja Hintermann, Gregor Müller, Monika Schneider, Daniela Schraner, Marisa Vivalda

The main goal of the ARI Administrative Services team is to provide an excellent Service in all administration and organization fields of the AO Research Institute Davos (ARI) and to numerous AO Partners.

- Organize the ARI Directors office
- Professional office management in English and German
- Correspondence
- Organization of meetings and minutes taking
- Preparing presentations
- Organize expense accounts
- Hotline and main contact for ARI
- Time management and control of ARI projects
- Travel organization for ARI employees and AO Partners
- Organization of congresses and events for ARI and part of the organization where ARI is represented at major AO events. This service is also offered to our AO Partners
- Supply the internal AO Research community (ARI, CID, Knowledge Services) with peer reviewed papers, book chapters, and books from sources all over the world
- Collation of all AO Research publications
- Purchasing for the AO Research Institute Davos
- ARI personnel management (support hiring, appraisal, organization etc.)
- ARI Fellowship organization and support



2011 the ARI Administrative Service Group has organized for:

### AO Research Institute (ARI)

15.-16.04.2011 Traumakurs für ETHZ und ZHAW Studenten in Davos  
22.-24.06.2011 eCM XII Implant Infection Congress in Davos

### AOTrauma Research Commission (AOTRC)

11.-12.03.2011 AOTrauma Middle East Research Forum in Dubai  
13.03.2011 AOTRC Meeting in Dubai  
25.06.2011 AOTRC Meeting in Davos  
08.10.2011 AOTRC Meeting in Miami  
09.12.2011 AOTRC Meeting in Davos

### AO Exploratory Research (AOER)

17.05.2011 AOER Board Meeting Zürich  
31.08.-01.09.2011 AOER Collaborative Research Program Meetings in Davos  
02.-03.09.2011 AOER Symposium "Where science meets clinics" in Davos

## 5. Institutional and Professional Relations

R Geoff Richards has appointments as honorary Professor at Cardiff School of Biosciences, Cardiff University, Wales, GB and at the Institute of Biological Sciences, Aberystwyth University, Wales, GB. He is an Honorary Senior Research Fellow in the Division of Infection and Immunity, University of Glasgow, GB. He is cofounder and Editor-in-Chief of the eCM Journal, past president of the Swiss Society of Biomaterials (also has Life Honorary Membership). He is a member of the Scientific Advisory Board of the Biomaterials Network and Member of Swiss Arab Postgraduate Clinical Academy Academic Advisory Board. He is a member of AO Foundation Academic Council and of the board of directors AOGCTM, from April-September was ad interim General Manager AO GCTM Pre-Clinical. He is a member and Director of the Board ("Stiftungsrat") of the Foundation of the AO Research Institute Davos. Geoff was appointed chair of the Infection & Inflammation Topic Committee, ORS (Orthopedic Research Society) in January 2011 and in September also an executive committee member for EORS (European Orthopedic Research Society). He also co-organized a Basic Science Focus Forum session again at the 2011 Orthopedic Trauma Association (OTA) annual conference in San Antonio, Texas in October.

Mauro Alini is an adjunct Professor at the division of surgery of the McGill University, Montreal, Canada and Professor (incaricato) at the faculty of science, division of biotechnology, of the University of Genoa. In April 2011, he was elected as President of The Swiss Bone and Mineral Society (two year term). He serves as a member of the Award Committee for The GRAMMER European Spine Journal Award. From 2010, he has been a member of the European Council of the Tissue Engineering Regenerative Medicine International Society (TERMIS). He is a member of the Scientific Editorial Board of the eCM Journal. He is Deputy Editor Section (Pathophysiology) of the BioMed Central Musculoskeletal Disorders and a member of the Editorial Board of the Open Orthopedic Journal, both online journals, as well as (until the end of 2011) to the Advisory Board of the Archives of Orthopedic and Trauma Surgery. He is also on the Editorial board of the Tissue Engineering Journal, Biomedical Material Journal and on the Assistant Editorial Board of the European Spine Journal.

Boyko Gueorguiev-Rüegg acts as journal reviewer for J Orthop Res, Arch Orthop Trauma Surg

Markus Wilke is a Diplomate of the American and European College of Veterinary Surgeons since 2003.

- Lukas Kamer is co-tutor for the focus field Medical Technology Industry, Dept. of Management, Technology and Economics, ETH Zürich.
- Fintan Moriarty is a member of the eCM Journal International Editorial Review Board.
- Hansrudi Noser is adjunct Professor at the Dept. of Informatics of the University of Zürich.
- Vincent Stadelmann lectures at The Swiss Institute of Technology Lausanne (taught 2 modules of the graduate course "*Biomechanics of the musculoskeletal system*" in 2011).
- Martin Stoddart is a Scientific Editor for eCM Journal and a member of the Review Editorial Board of Frontiers in Craniofacial Biology. He is also a co-organizer of the yearly eCM conference and a webeditor of eCM. He is an Associate Faculty Member of the Faculty of 1000 Medicine.
- Sophie Verrier is a member of the eCM Journal International Editorial Review Board.
- Markus Windolf acts as journal reviewer for J Biomech, J Orthop Trauma, J Orthop Res, Injury, Med Eng Phys, Vet and Comp Orthop Trauma and Arch Orthop Trauma Surg
- Yash Agarwal acts as journal reviewer for Vet and Comp Orthop Trauma. He is a member of ASTM International Technical Committee for F04 Medical and Surgical materials and Devices (voting member) and for E08 Fatigue and Fracture (non-voting member).

## 6. Good News

### Awards

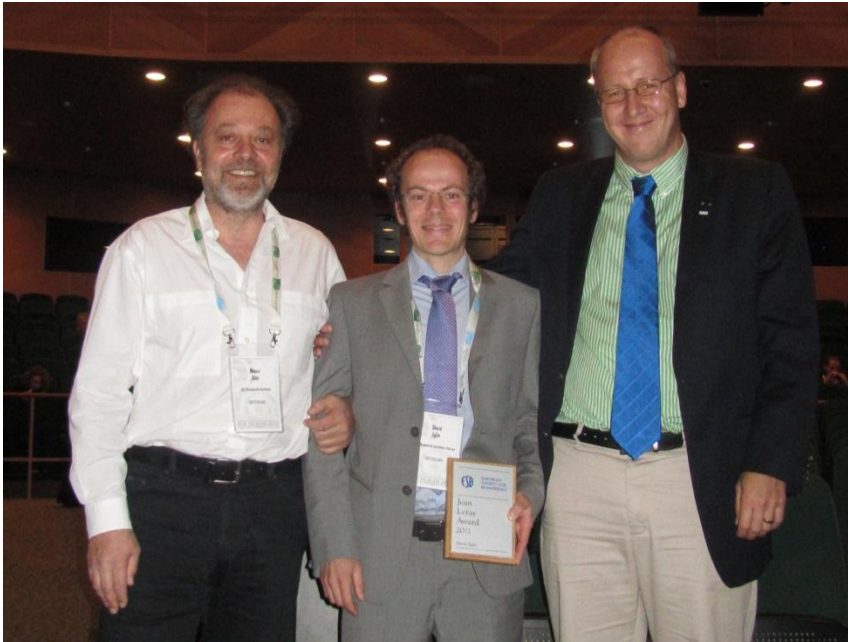

Dr. David Eglin received the 2011 Jean Leray award. (From left to right: Mauro Alini, David Eglin, Geoff Richards).

The contribution of the AO Research Institute Davos to the field of biomaterials has again been recognized by The European Society for Biomaterials (ESB). The society has nominated Dr. David Eglin as the recipient of this year's Jean Leray Award. This prestigious award is established to recognize, encourage and stimulate outstanding research contributions to the field of biomaterials by young scientists and is given to a researcher under 40 who has demonstrated distinctive achievement and insight in biomaterials research. Dr. David Eglin is a principal scientist and leader of the Polymers and Surfaces team in the Musculoskeletal Regeneration program (Prof. Mauro Alini) at the AO Research Institute Davos in Switzerland. His research interests lie in macromolecular chemistry and material science, focusing on polymers for medical devices, tissue engineering and regenerative medicine. He develops scaffolds, membranes and hydrogels for both the understanding of cell-material interactions and for translational research in the orthopedic field.



Fellow Mark Lenz won third prize at VLOU 2011, Jena (D), for his oral presentation: Die proximale Fixation periprothetischer Femurfrakturen. Eine biomechanische Studie zum Vergleich zweier Techniken.



Apprentice Noel Wyss (left) won the Fraisa ToolChampions first prize (division: CNC) for the German-speaking part of Switzerland.

## Key Performance Indicators

The ARI average impact factor of the publications has been steadily rising and in 2011 reached 3, which is an extremely good value in the trauma field. The extramural funding also nearly reached 3 million increasing 1/3 from 2010.

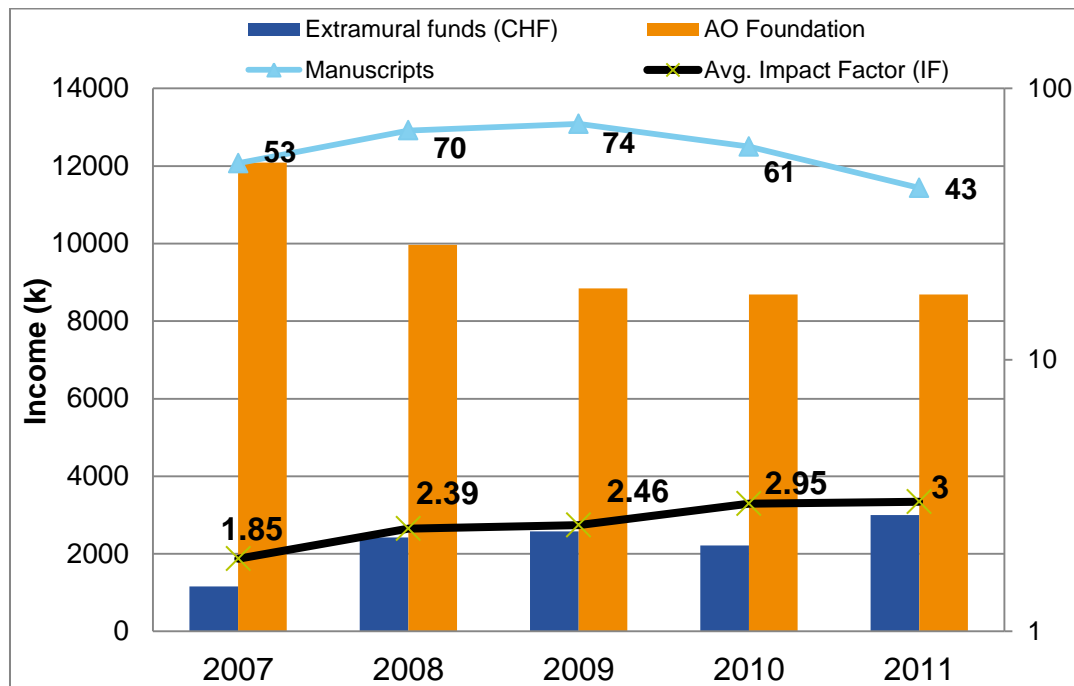

## Extramural funding

### European Commission funded research project (seventh framework program) (EU FP7) Grants

GAMBA: Gene Activated Matrices for Bone and Cartilage Regeneration in Arthritis. ARI personnel: Mauro Alini, Ludovic Bouré and David Eglin; 457,800€ in total (2010–2013).

NPMimetic: Biomimetic nano-fiber-based nucleus pulposus regeneration for the treatment of degenerative disc disease. ARI personnel: Mauro Alini and Sibylle Grad; 532,000€ in total (2011–2015).

BIODESIGN: Rational Bioactive Materials Design for Tissue Regeneration. ARI personnel: Mauro Alini, Martin Stoddart, 590,000€ in total (2012–2016).

'BALI' in HEALTH 2011.2.3.1-5 Development of tools to control microbial biofilms with relevance to clinical drug resistance was approved in collaboration with AO AOCID, (ARI personnel: Fintan Moriarty, Stephan Zeiter, CID personnel: Andy Faeh 595,000 Eur (ARI -317,000 Eur; CID - 277,000 Eur) in total over 3 years. ARI researchers (with 6 partners) aim at preventing and treating biofilm related bone infections by combination of antimicrobial agents within a controlled antibiotic release strategy.

## Other Grants

In recognition of the high standard of research being performed at the ARI, the Innovation Foundation of the canton of Graubünden has awarded 632,000 CHF for a new Fluorescence activated Cell Sorter which will greatly increase the capabilities within the cell and stem cell areas. The device is capable of counting up to 70,000 events per second and can reliably sort cells at a rate of 20,000 cells per second. The cells can easily be separated by type and then further cultured to determine function. The new 4 laser device is a fantastic addition to ARI and, along with its new dedicated FACS operating technician (Ursula Menzel), is a vital support area for many projects.

The ARI has been granted a 2011 Marie Curie Initial Training Networks grant (a PhD student cost, EUR 275'000/4 years) has now been approved (ARI personnel: Mauro Alini, Marianna Peroglio).

US National Institutes of Health NIH contract through Prof Chris Evans, Harvard. The *in vivo* study investigates Healing of Segmental Defects of Bone & Gene Transfer Treatment of critical sized large bone defects using genetically modified fat and muscle, 636,336 US\$ over five years. (2011–2016).

Prof Mauro Alini was awarded funding by the North American Spine Society 2010/2011 Basic Research for 2 years. Stem Cell Based Intervertebral Disc Regeneration-Evaluation in Organ Culture. (\$50,K / year)

### New Musculoskeletal Infection labs

In May 2011 ARI's new musculoskeletal Infection laboratory became operational. The new laboratory was built in what were previously the Biomedical Services cadaver preparation rooms, which were vacated in the modernization and extension of the new preclinical facility. The decision by AOTRC to nominate bone infection as a clinical priority program (starting in 2012) prompted the move to larger laboratory space as a greater number of internal and collaborative projects on bone infection are being initiated. The new infection laboratories feature two new class II biosafety cabinets which ensure best practices and safety for personnel when working with the bacterial pathogens most commonly encountered in bone infections.



### New anatomical wet specimen laboratory

With the completion of the new preclinical facilities, the former operating room (OR) area within the AO Center was transformed into an anatomical laboratory. The new facility includes two workplaces, equipped with a radiolucent OR tables, a C-arm and balanced LED lights to mimic surgical conditions. A high resolution camera system, integrated into the OR light, is available for larger groups, documentation and educational purposes. The team maintains an enhanced database of human anatomical specimens dedicated to specific research questions with ethical approval and support of certified collaborators. The mechanical test park was relocated adjacent to the anatomical laboratory area comprising electro-static, electro-dynamic and hydraulic material test systems for performing biomechanical in-vitro and ex-vivo studies on the specimens. Research specific testing protocols are offered, tailored to the scientific questions. The anatomical specimen unit is supported by a prototype tool shop for quick and precise realization of innovative and matured ideas in the field of osteosynthesis. The new infrastructure provides a supportive and inspiring environment for surgeons, Expert-Groups and researchers.





Dr. Martin J. Stoddart was invited to plan, implement and be the only editor of a new book in the Methods in Molecular biology series. Entitled "Mammalian Cell Viability Methods" it includes a number of chapters with numerous ARI contributors. The book is now published and available through Springer.

Prof Geoff Richards, co-organized with Dr Ted Miclau (San Francisco, USA) a Basic Science Focus Forum on infection at the Orthopedic Trauma Association (OTA) conference in San Antonio, Texas, at which he and Dr Fintan Moriarty (ARI) presented on Implant surfaces and anti-infective surfaces respectively.

### Visit from ETHZ Foundation

Corrine Adler of ETHZ Foundation visited R. G. Richards to follow up on discussions last year with Prof Eichler (ETHZ president) on the ARI's involvement in the ETHZ's new faculty of Human Health Sciences & Technology which will have over 30 professors and more than 400 researchers in their new purpose built facility starting in early 2012. The ARI will be involved with teaching in the postgraduate part of a new course within this faculty. The ARI therefore has the chance of promoting its younger researchers as lecturers within the faculty which will help keep the young talent within ARI.

### Collaboration RMS Bettlach:

R. G. Richards visited the Robert Matthys and Beat Gasser of the Robert Mathys Foundation (RMS) in Bettlach to renew collaborations. The RMS board and research group leaders visited the ARI on May 20th and the ARI and RMS showed each other their capabilities to allow development of collaborative research projects and to look at the possibility of collaborative service offerings through AOGCTM, where RMS and ARI have different strong capabilities, which may encourage more customers benefiting both groups. The next steps are to select one or two of the topics in common and to organize a next meeting with the responsible and involved representatives of both institutions to do a brain storming, to define a common project.





Congratulations to Suthorn Bavonratanavech for becoming president elect for the AO Foundation which was celebrated at the The Royal College of Orthopedic Surgeons of Thailand meeting held jointly with the 31<sup>st</sup> ASEAN Orthopedic Association meeting in October 2011 in Pattaya, Thailand where I was honored to give keynotes on our work and the AO which set more connections for AO to Asian societies. Below, the Thailand AO alumni including vajara phiphobmongkol, the current trustee (standing second from far right).



Dr. Slobodan Tepic, Prof. Stephan Perren and Geoff Richards meet at the 2011 Davos Courses. Tepic and Perren together designed the point contact plates with locking screws, the locking plate technology that is the basis of all locking plates used throughout the world today. Geoff is proud to have had such scientific mentors at the ARI from the early 90's onwards. Their passion still remains. This technology was combined together with the previously developed technology of the Dynamic Compression Plate (DCP) (Perren) by Röbi Frigg to produce today's successful Locked Compression Plate (LCP), the mainstay of Synthes, based upon two concepts from the ARI.

## 7. eCM Journal and Conference

eCM Open Access Journal, published by AO Research Institute Davos

Journal Citation Reports® 2011 released in June listed eCM with an Impact Factor (the average number of citations to papers published during the preceding two years) for 2010 of 9.65 (2009- 4.289, 2010 - 5.378), keeping eCM as the number 1 journal in musculoskeletal research. The journal also had surpassed the 12000 registered readers and achieved the first 3000 linkouts in a month from PubMed (direct links made from the PubMed entries to papers in eCM) from 6500 monthly visits (Google Analytics). In 2011, eCM has also become the official Research Journal of AO CMF and AO Trauma.

2011 eCM XII Implant Infection conference.

eCM XII was held at the Congress Center Davos, from June 22-24, 2011. Approximately 160 participants travelled to Davos for this year's eCM from as far away as New Zealand, Australia, Malaysia, India, Columbia, USA, Middle East in addition to many from Europe. The scientific program was arranged by the conference organizers Fintan Moriarty, Martin Stoddart and Geoff Richards from the ARI. The conference was arranged in single sessions covering the problem of infection from a clinical perspective as well as translational research into anti-infective solutions and basic research into bacterial pathogenicity, with each session starting with two keynote lectures by recognized experts in their fields.

This was the first eCM meeting to focus on infection, which was prompted by the decision by the AO Trauma research commission (AOTRC) to set up a new clinical priority program (CPP) on bone infection. eCM XII Implant Infection was the first joint meeting with the Asia Pacific Orthopedic Association Infection Section (APOA) set through Dr Sureshan Sivananthan, Vice Chairman of the APOA Infection Section. The APOA also hosted their Musculoskeletal Infection prize competition at eCM. Over the three days, four pre-selected entrants were invited from a large number of applicants to present their work and compete for the USD 10,000 APOA-Pfizer award for best paper.

[Read further...](#)



A large number of participants joined in the first eCM conference focused upon the problem of infection (above).

The APOA prize for Infection research was awarded to Brit Wildemann from Berlin and was presented with her prize by Bill Costerton (known as the "father of Biofilms" for his pioneering research in the area who unfortunately passed away in May 2012 losing his fight against pancreatic cancer).

## 8. AO Research Institute Fellows

A total of 22 fellows (medical and Research) spent between a few months and twelve months in one of the research areas in the ARI, working in ongoing basic and applied research projects, all of which derive from clinical problems. The purpose of the ARI Medical Research Fellowships is to provide motivated surgeons on-site scientific training to gain experience in relevant clinically focused R&D projects.

Below is a list of the 2011 Fellows and which area they worked in, some with short quotations.

- Giuseppe Alajmo, Hospital Universitario Fundacion Santafe de Bogotá, Colombia  
ARI project: Innovations Group (Surgical Skills Teaching technology development)
- Hayder Al-Saadi, Rashid Hospital and Trauma Center, Dubai  
ARI project: Musculoskeletal Infections Group (Infected Osteosynthesis)
- Balazs Bago, University of Szeged, Hungary  
ARI project: Human Morphology Services (Computerized Preoperative Planning)  
*This institute is a very good place to get interdisciplinary knowledge, since here you can find researchers from different fields of science; this is very important at my work, because I can collaborate with the future "users". Above the work, working at AO gives a good possibility to learn interesting news about different cultures, as workers, fellows and researchers are coming from all around the world. Davos is a very nice place for the AO Institute, good to be here.*
- Aswin Beck, Veterinary Medicine, Ghent University, Belgium  
ARI project: Preclinical Services Program (Preclinical Surgery)
- Lorenzo Calabro, Princess Alexandra and Queen Elizabeth II Jubilee hospitals, Brisbane, Australia  
ARI project: Musculoskeletal Infections Group (Fracture fixation associated osteomyelitis)
- Iska Dresing, University of Veterinary Medicine Hannover, Germany  
ARI Project: Preclinical Services Program (Preclinical Surgery)  
*I was integrated very well from the beginning and got the opportunity to get in touch with skilled people from all over the world and to develop my veterinarian abilities. I was impressed by the multiple research fields, the different AO specialties and the teamwork.*
- Fabian Duttenhofer, Albert-Ludwigs University, Freiburg im Breisgau, Germany  
ARI Project: Musculoskeletal Regeneration Program (Bone Regeneration)
- Abhay Gahukamble, Paediatric Orthopedic Unit, Christian Medical College, Vellore, India  
ARI project: Musculoskeletal Infection Group (fracture fixation associated osteomyelitis)  
*The time spent at the ARI has been very useful and educational. The expertise in the various interconnected fields dealing with the musculoskeletal system which is found under one roof in the ARI is a testament to the excellent research that has been done in the past and no doubt will continue in the future. The staff is warm and encouraging and the atmosphere allows a healthy exchange of ideas and skills. It has been exciting to join the ARI team in Davos and the knowledge and experience gained here will be an asset in the future.*
- Rafael Lara de Freitas, Hospital das Clinicas da Faculdade de Medicina, Ribeirao Preto-USP, Brasil  
ARI project: Musculoskeletal Regeneration Program (Bone Regeneration)
- Marz Lenz, Friedrich Schiller University, Jena, Germany  
ARI project: Biomedical Services Program (Biomechanical Testing)
- Cameron Lutton, Institute of Health and Biomedical Innovation (IHBI), Queensland, Australia  
ARI project: Musculoskeletal Infections Group (Infection Models)

- Andy Mahoney, University of Arizona, Arizona, USA  
ARI project: Innovations Group (Playground Development)
- Albrecht Popp, Insel University Hospital Bern, Switzerland  
ARI project: Biomedical Services Program (Osteoporosis Research)
- Julián Salavarieta, Orthopedics and Traumatology at the Hospital Universitario Fundación Santa Fe de Bogotá, Columbia  
ARI Project: Musculoskeletal Infection Group (Bacterial Metal Interactions)  
*I am having a wonderful time in the ARI, it is so exciting to work with young scientists, it is so interesting to learn from them and know how they understand and how they think about the challenges that surgeons have in the clinics, they look at everything from another point of view and I think is so positive to work together and try to find common pathways. For me it is wonderful to work in the lab and to learn a lot of new things, but the best of everything is to have the opportunity to have friends, so for me this time at AO gives me the opportunity to meet a lot of good people, not only for my career but for my life.*
- Claus Seyboth, Limb Lengthening, Reconstruction and Deformity Correction, Trauma, Hand surgery and Microsurgery, Hospital Universitario Cajuru, Curitiba, Paraná, Brazil  
ARI Project: Musculoskeletal Infection Group (implant topography and tissue integration)  
*We receive information, instructions, and knowledge of the rules, and when you realize, you are integrated in the group, interacting with everyone and comfortably enjoying your job. It is amazing how you can draw a study and plan all the steps to achieve the results. This includes reading the literature, making the study plan, passing through the histology, pathology, clinical and surgical experiments, evaluation of the results, interpretation and getting conclusion: here the real research happens. I'm really glad doing real research, sharing my clinical experience and thank again AO Foundation for this opportunity.*
- Florian Schmidutz, Ludwig-Maximilian University, Munich, Germany  
ARI project: Preclinical Services Program (Tissue Morphology)  
*"At the end of my medical research fellow ship, I want to take the opportunity to thank the AO for being able to joint this outstanding research facility for one year. It was a valuable experience for me and I have learned more than I have expected. I also would like to thank the entire staff for sharing their huge research experience and knowledge with me."*
- Josh Schroeder, Hadassah University Hospital, Jerusalem, Israel  
ARI Project: Musculoskeletal Regeneration Program (Stem Cells and Disc Regeneration)
- Yasuyuki Shiozaki, Okayama University, Okayama, Japan  
ARI Project: Biomedical Services Program (Biomechanical Testing)  
*I like working at AO. All colleagues are kind and knowledgeable. We can use a range of different instruments for our experiments. This is a very comfortable situation for an orthopedic surgeon.*
- Desislav Valchev, Orthopaedic and Trauma Department, University Hospital Saint Anna, Sofia, Bulgaria  
ARI Project: Biomedical Services Program (Biomechanical Testing)  
*With all of the projects I have learnt a lot about biomechanical testing, how to use statistics to evaluate the significance of the tests results, how to work with CT-scans like clinical CT, extreme CT and micro CT. I also have learnt how to develop new projects from the ideas. In my opinion it is very good for the future for everyone who was a fellow at the ARI; he/she will know how to reach people, how to use the benefit that AO Foundation is giving, and exactly connect the science and the specialists.*
- Ulf Viehhofer, RWTH-Aachen, Germany

ARI Project: Biomedical Services Program (Models for Spinal Irrigation Systems)

- Endre Varga, University of Szeged, Hungary  
ARI project: Preclinical Services Program (Human Morphology Services)
- Sandra Wissing, University of Leipzig, Germany  
ARI Project: Innovations Group (Research Implant System)  
*With a background as a veterinarian I got the great opportunity to combine my interests in art with medical issues. I was admitted to my team very well and got great support from different departments of the AO. The time I spent at the AO during my fellowship had a huge influence: Regarding medicine from another point of view I figured out that I would like to strike a completely new path concerning my medical career.*

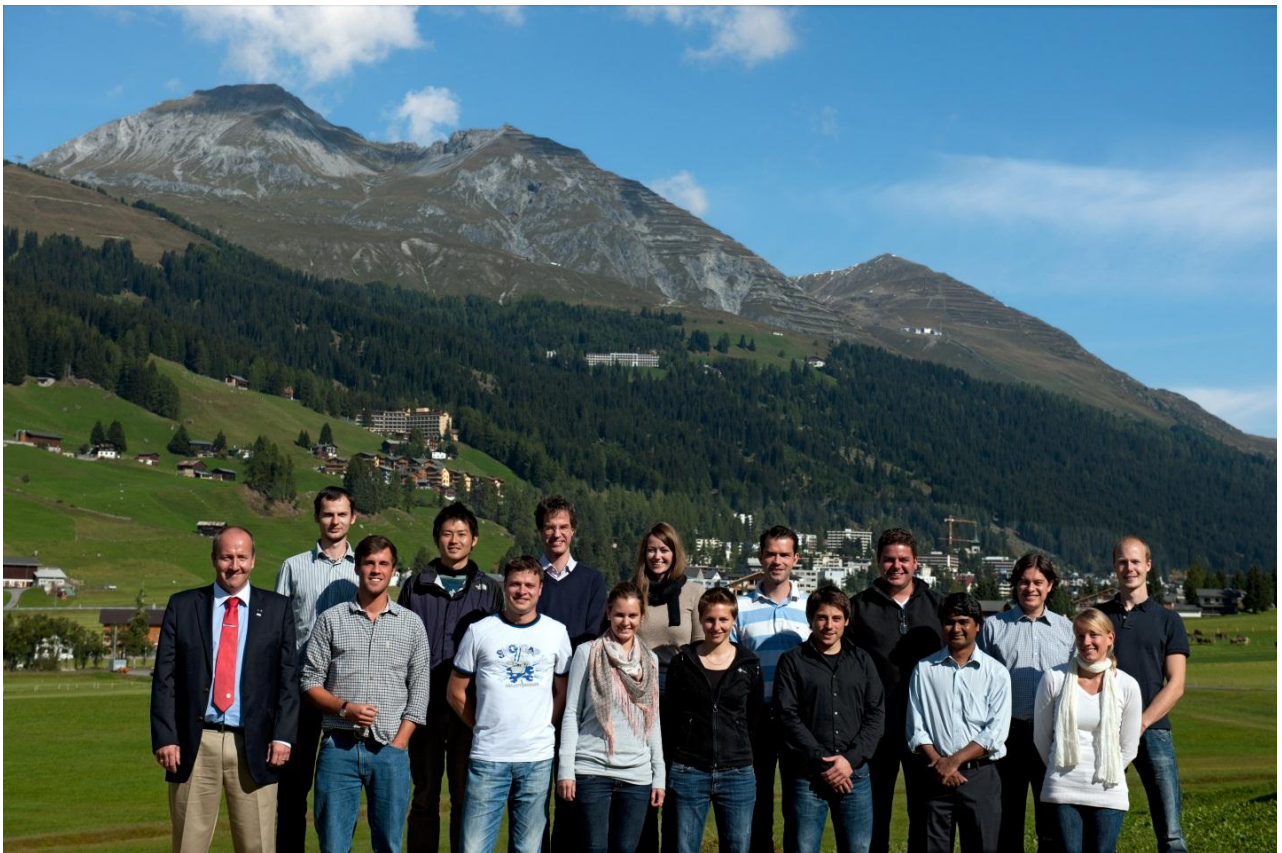

Geoff Richards, Balazs Bago, Julian Erggelet , Yasuyuki Shiozaki, Desislav Valchev, Mark Lenz, Nadine Wismer, Sandra Wissing, Ursula Eberli, Florian Schmidutz, Ulf Viehöfer, Claus Seyboth, Abhay Gahukamble, Julian Salavarrieta, Judith Staudacher, Tobias Reuber

## 9. Project Abstracts by Specialties

### AOTrauma

#### Biomechanical investigation of distal screw breakage in tibia nails comparing locked and unlocked screws (LockNail 5)

**Problem:** Tibia nail interlocking screw failure often occurs during delayed fracture consolidation or at early weight bearing of nailed unstable fractures, in general when high implant stress could not be reduced by other means. **Goal:** To investigate whether there is a biomechanical improvement in long-term performance of angle-stable locking screws compared to conventional locking screws for distal locking of intramedullary tibia nails. **Results:** Angle-stable locking screw constructs exhibited significantly higher stiffness values and provided a longer fatigue life, expressed in a significantly higher number of cycles to failure compared to conventional locking screw constructs. Fatigue performance of locking screws can be ameliorated by the use of angle-stable locking screws, being especially important if the nail acts as load carrier and an improved stability during fracture healing is needed.

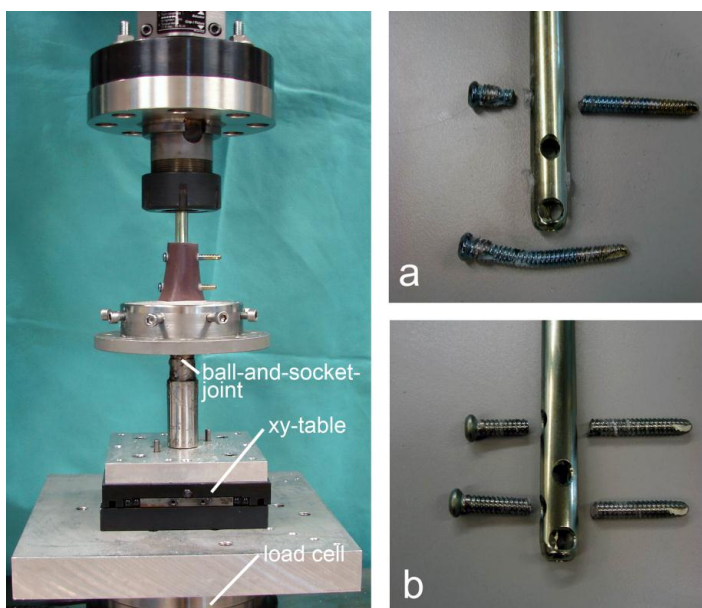

#### Partners:

- Dankward Höntzsch, MD PhD, Dept. of Medical Technology Development, BG Trauma Hospital Tübingen, Schnarrenbergstrasse 95, D-72076 Tübingen, Germany

#### A novel approach for simplified computer aided surgery, exemplified on nailing of proximal femur fractures (SimpCAS X-in-one) (Ongoing)

**Problem:** Current solutions for computer aided surgery lack wider acceptance due to considerable disadvantages regarding complexity, costs and effectiveness. **Goal:** A simplified computer aided surgery system shall be developed utilizing a conventional C-arm as imaging and navigation means rendering additional tracking and imaging equipment unnecessary. The concept aims to improve surgical routine tasks and shall be exemplified on intramedullary nailing for enhanced fixation of osteoporotic hip fractures. **Results:** A prototype system was developed for the PFNA (Synthes GmbH) supporting the entire nailing procedure, namely 1. placing a blade implant centered in the femoral head, 2. adjusting the anteversion of the femur, before 3. locking the nail distally in place. Another patent was submitted to strengthen the AO intellectual property rights.

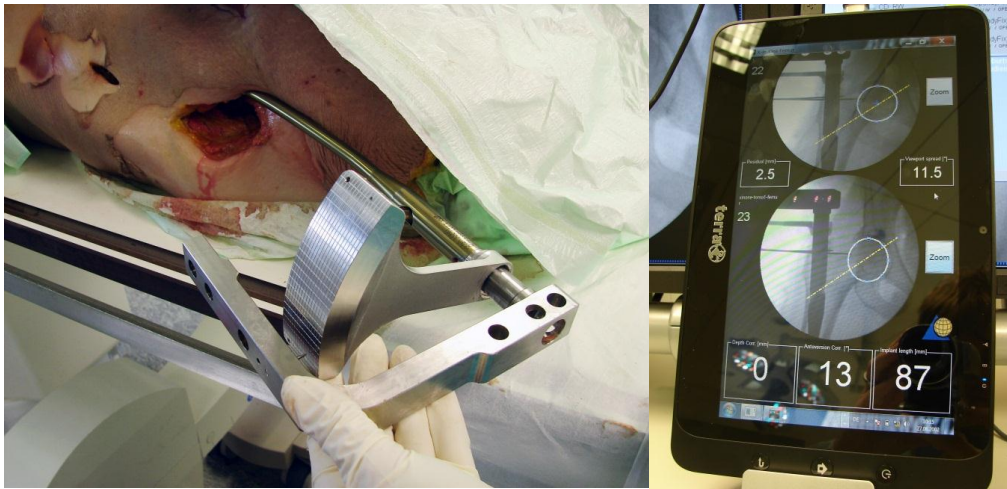

**Pres:**

Fliri L, Schroeder J, Richards RG, Windolf M. A novel technique for simplified distal interlocking of IM nails to reduce radiation exposure. 2011. DGU / DKOU.

Schroeder J, Fliri L, Liebergall M, Richards RG, Windolf M. A novel technique for simplified distal interlocking of intra medullar nails to reduce radiation exposure. 2011. CAOS

**Partners:**

- Mosheiff R, Hadassah University Hospital, Jerusalem, Israel
- Liebergall M, Hadassah University Hospital, Jerusalem, Israel

**Development of a dynamizable internal fixator system for large animal bone research with biofeedback technology (ImpCon) (Ongoing)**

Problem: Various attempts have been undertaken to clinically take advantage of fostered bone formation under mechanical stimulation of the fracture. However, the phenomenon is not fully understood and requires further investigation. For this reason, research and clinical applications with biofeedback systems, characterizing the healing process are gaining importance, but feasible solutions are still missing. Goal: To develop and extend the portfolio of a recently introduced plating concept to serve as an advanced implant system for bone research using large animal models by stimulating and monitoring of the healing process in a wireless fashion. Results: The developed implant system was further refined, tested in-vitro in several biomechanical settings and is currently applied in a pilot animal in a sheep tibia defect model. The system appears capable of continuously monitoring the progression of callus formation over several months without the need for external power supply, standardized physiological loading conditions or extensive data transfer.

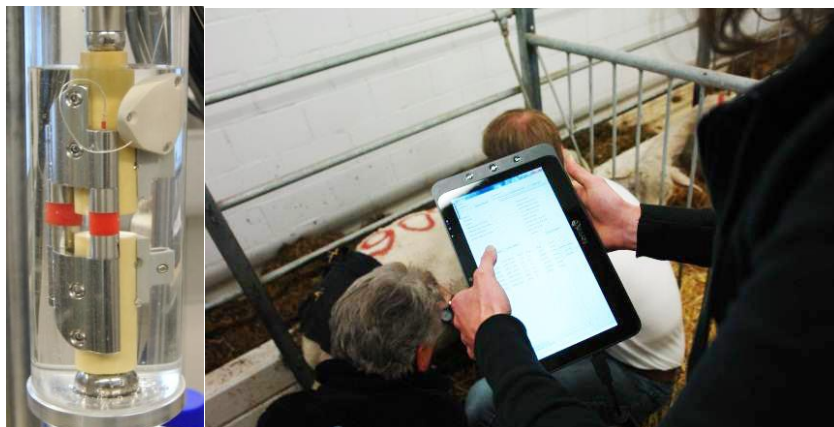

**Partners:**

- Mathis H, Institute for Communication Systems, Hochschule für Technik, Rapperswil, Switzerland



## Intraoperative assessment of bone quality (CPP1 BoneQual)

Problem: Osteosynthesis failure in osteoporotic bone. Goal: Development of a concept for intra-operative measurements of bone quality in osteoporosis relevant regions such as hip, proximal humerus, foot and spine in order to help in decision making whether additional implant stability via augmentation techniques is needed. Results: Clinical studies on hip and spine were completed. The clinical potential of the concept was proven.



### Pres:

Klos K, Gras F, Windolf M, Gueorguiev B, Hofmann GO, Mückley T. Verschiedene Verfahren der Knochendichtemessung am Rückfuss und sich daraus ergebende Konsequenzen. Eine biomechanische Studie? 2011. VLOU.

### Pub:

Brianza S, Röderer G, Schiuma D, Schwyn R, Scola A, Gebhard F, Tami AE. Where do locking screws purchase in the humeral head? Injury. 2011 Nov 14. (epub ahead of print)

Klos K, Mückley T, Wähnert D, Zwipp H, Gueorguiev BG, Schwieger K, Hofmann GO, Windolf M. [The use of DensiProbe™ in hindfoot arthrodesis. Can fusion failure be predicted by mechanical bone strength determination?]. Z Orthop Unfall. 2011;149(2):206-11.

### Partners:

- Benneker L, Department of Orthopedic Surgery, Inselspital, Bern, Switzerland
- Suhm N, University Hospital Basel, Basel, Switzerland
- Blauth M (CPP FFOB), Medical University Innsbruck, Austria
- Weber A, Task Force Osteoporosis, Synthes, Solothurn, Switzerland

## Cement augmentation methods for improved fracture fixation in osteoporotic bone (ImplantAug) (ongoing)

Problem: The treatment of fractures in elderly patients remains a challenge in trauma surgery. Post-operative fixation failure is frequently seen in various anatomical regions. Improved implant purchase is required to reduce the risk of failure in order to allow for early and confident mobilization of elderly patients. Goal: The objective of this ongoing project is to evaluate potential implant augmentation procedures at several anatomical key locations in terms of risk factors and biomechanical benefits in osteoporotic bone. Furthermore it is aimed to support the development process of new augmentation related fixation devices and surgical cement injection procedures to optimize and establish the concept in clinics. Results: A clear biomechanical improvement in terms of implant stability was shown for the augmentation of the Proximal Femoral Nail Antirotation (PFNA), where the cement is injected through a cannulation and perforations after the insertion of the implant. It was also shown that bone marrow modified cement has the potential to increase the compliance of PMMA cement for use in cancellous bone, especially due to its lower polymerization temperature and elevated initial viscosity. At the same time, it could be shown that a stiffness modification of bone cement does not lead to an improvement of the load distribution at the bone-cement interface and hence, does not reduce peak stresses.



**Pres:**

Arens D, Rothstock S, Windolf M, Gueorguiev B, Boger A. Mechanical, thermal and rheological properties of acrylic bone cement modified with bone marrow. 2011. SSB.

**Theses:**

Eberli U. The influence of bone cement stiffness modifications on implant anchorage in osteoporotic bone. 2011. ETH ZH - Departement Biologie - Bewegungswissenschaften und Sport (MSc / Müller R, Lorenzetti S, Gueorguiev B, Fliri L).

**Pub:**

Arens D, Rothstock S, Windolf M, Boger A. Bone marrow modified acrylic bone cement for augmentation of osteoporotic cancellous bone. *J Mech Behav Biomed Mater.* 2011;4(8):2081-9.

Sermon A, Boner V, Boger A, Schwieger K, Boonen S, Broos PL, Richards RG, Windolf M. Potential of polymethylmethacrylate cement-augmented helical proximal femoral nail antirotation blades to improve implant stability - A biomechanical investigation in human cadaveric femoral heads. *J Trauma Acute Care Surg.* 2012;72(2):E54-9 (*epub 2011 July 7*).

Sermon A, Boner V, Schwieger K, Boger A, Boonen S, Broos P, Richards G, Windolf M. Biomechanical evaluation of bone-cement augmented Proximal Femoral Nail Antirotation blades in a polyurethane foam model with low density. *Clin Biomech (Bristol, Avon)* 2012;27(1):71-6 (*epub 2011 Aug 7*).

**Partners:**

- Blauth M (CPP FFOB), Dept. of Surgery and Sports Medicine, Medical University Innsbruck, Austria
- Weber A, Task Force Osteoporosis, Synthes, Solothurn, Switzerland
- Boger A, Biomaterials, Synthes, Oberdorf, Switzerland
- Van Lenthe H, Müller R, Institute for Biomechanics, ETH Zurich, Switzerland

**Prophylactic reinforcement of the proximal femur to prevent secondary hip fractures (ProphylacticAug) (ongoing)**

Problem: Hip fractures, due to osteoporosis, are associated with a high risk of secondary fractures at the contralateral side. Mortality can be significantly increased after a secondary hip fracture. Due to low compliance, hip protectors have not proven to lower the fracture risk and the effect of pharmacological treatment for osteoporosis is often too slow to reduce secondary hip fracture incidence. Therefore, a prophylactic mechanical reinforcement of the contralateral limb during operation of the initial fracture could be of interest in highly osteoporotic cases. Goal: It is aimed to develop a procedure to prevent secondary hip fractures by reinforcing the intact contralateral femur mechanically. Results: In a first approach proximal femora augmented in a V-shaped configuration showed significantly increased energy absorption until fracture compared to paired non-augmented control samples. Despite these very

promising results, many questions remain open before the clinical relevance of this technique can be clarified. A parametric analysis in a computational environment is currently running in order to systematically derive an optimized prophylactic reinforcement concept in terms of material properties, volume and location.

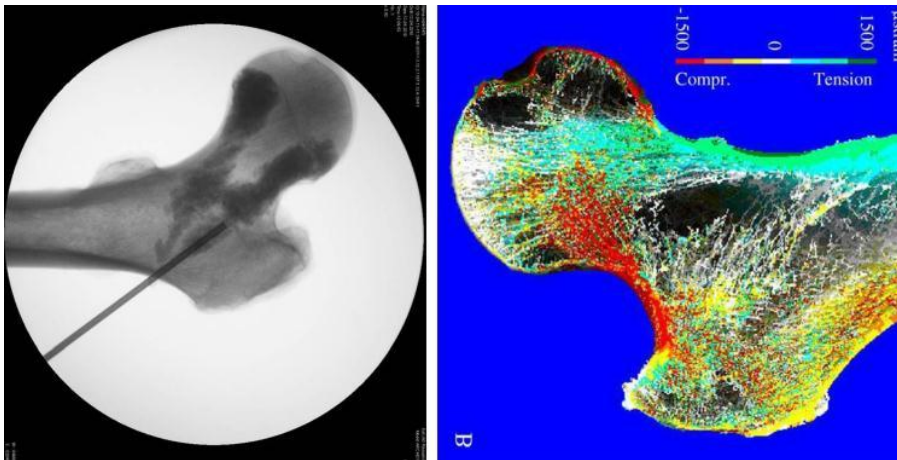

**Pres:**

Fliri L, Wähnert D, Sermon A, Schmoelz W, Blauth M, Boger A, Windolf M. V-shaped cement augmentation of the proximal femur to prevent secondary hip fractures. 2011. ESTES.

**Partners:**

Blauth M (CPP FFOB), Department of Surgery and Sports Medicine, Medical University Innsbruck, Austria  
Schmölz W, Medical University Innsbruck, Austria

Van Lenthe H, Institute for Biomechanics, ETH Zurich, Switzerland

Boger A, Biomaterials, Synthes, Oberdorf, Switzerland

### Repair of osseous defects using resorbable implants in a sheep model (PLsheep) (completed)

The aim of this project was to investigate the tissue reaction on spongiosa implants in the proximal tibia of the sheep. Animal experiments were carried out at the Ludwig-Maximilians-University (LMU) in Munich and analysis was performed at the ARI. The study evaluated three different groups of sheep: two treatment groups with a spongiosa implant (evaluated after 6 resp. 12 months). The third group comprised the control group with an empty defect (evaluated after 6 months). After histological processing of the tissue samples, a pathological investigation on Giemsa-Eosin stained sections was performed and the bone content of the defects were measured by a histomorphometric analysis, consisting of five regions: three inside and two outside of the created defect (see figure below). No negative tissue reaction caused by the spongiosa implants was seen. In the control group, bony in-growth from the outside of the empty defect could be observed after 6 months. In the two treatment groups with a spongiosa implant an increased bone formation outside of the defect and a slow bone formation inside of the defect was observed after 6 and 12 months.

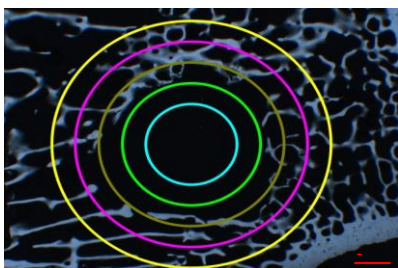

**Partners:**

- Sichler AM, Ludwig-Maximilians-Universität München, Germany
- Milz S, Anatomische Anstalt der Ludwig-Maximilians-Universität München, Germany

## Resorption characteristic of ChronOS™Inject in metaphyseal bone defects of distal radius fracture (Radfrac)

Resorbable calcium phosphate cement is frequently used in human patients. However, up to now, data regarding resorption characteristics of ChronOS™Inject in metaphyseal bone defects is lacking. Distal radius fractures of six elderly patients (average 70 years) were treated with a volar locking plate system. The metaphyseal bone defect was filled with ChronOS™ Inject during surgery. At the time of implant removal (average 11 months postoperatively), a biopsy (Ø 2 mm) was obtained from the region of the previous ChronOS™Inject injection. Evaluation was performed on decalcified thin histological sections from the biopsies including the cement particles. Analysis showed signs of inflammation as well as bone marrow fibrosis. The amount of bone in the measured areas varied between 6.9 and 36.2% in comparison to the amount of osteoid between 0.5 and 7.8%. Noticeable, patients receiving osteoporosis medication had a lower ratio between bone and osteoid compare to patients without. In conclusion, the present study shows, that ChronOS™ Inject is still detectable in human patients 15 months after injection into a distal radius bone defect. However, it could be shown that during the tissue remodeling process ChronOS™ Inject is transformed into the trabecular bone.

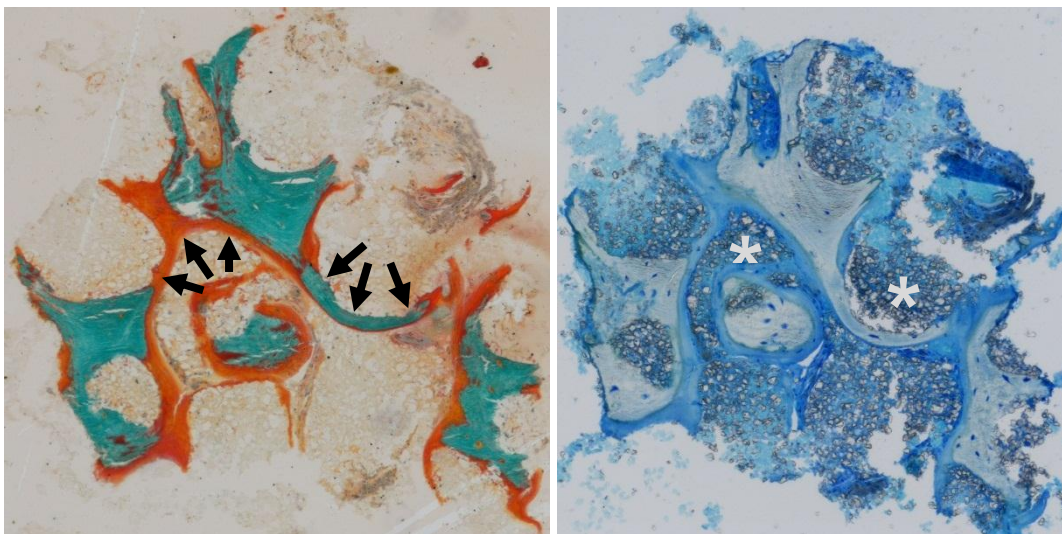

Histological sections of a bone biopsy: In the Masson-Goldner trichrom stain (left) the mineralized bone tissue (green) is surrounded by un-mineralized osteoid (orange, scale bar = 200 µm). The granular ChronOS™ Inject particles are not stained, but the outline of a cement granule can be depicted (arrows). In a neighboring section stained with Methylene blue (right), the area occupied by the ChronOS™ Inject granules (\*) is filled with grey grained material (scale bar = 200 µm). Note that part of the ChronOS™ Inject material is lost during the histological preparation and only the void formerly occupied by the material is left.

### Partners:

- Milz S, Anatomische Anstalt der Ludwig-Maximilians-Universität München, Germany
- Lutz M, Arora R, Sitte I, Blauth M, Department of Surgery and Sports Medicine, Medical University Innsbruck, Austria

## 3D statistical bone density distribution at anatomical key regions and its application for osteosynthesis optimization in osteoporotic bone - technical feasibility study in the distal tibia.

Introduction: Fragility fractures involve all kinds of bones. Apart from spinal fractures predominantly metaphyseal areas of long bones are affected. Fracture fixation may be compromised by a reduced bone mass and altered bone structure which may result in an increased number of complications and fixation failures. Clinical outcome could be improved by increasing the anatomical knowledge about the statistical spatial distribution of the local amount of bone available in osteoporotic key regions and about its intra- and inter-individual variations. Transferring these data to computer simulations might be useful for systematically improving implant anchorage in osteoporotic bone.

Aims: The objectives of this study are: 1) based on peripheral quantitative CT (pQCT) scanning to perform a 3D anatomical study of metaphyseal sites of osteoporosis relevant regions, creating 3D statistical anatomical computer models of osteoporosis key regions (=3D BMD maps), in order to demonstrate the inter- and intra-individual spatial variations of the bone mineral density (BMD), and to identify potential anatomical sites showing invariable, good bone stock with regard to BMD. 2.) to define a standardized interface to incorporate 3D BMD maps into existing finite element approaches to virtually test implant designs and locations in terms of fixation strength. 3.) to assess the feasibility of the concept on a representative region (proximal Femur).

Materials & Methods: This x-ray based 3D anatomical study will cover five metaphyseal sites of osteoporotic key regions; i.e. the distal radius, the proximal humerus, the proximal and distal femur, as well as the proximal tibia. The technique for creating 3D BMD maps was elaborated in a technical feasibility study performed for the distal tibia.

For each region we propose pQCT scanning a series of  $\geq 60$  fresh frozen bone samples of human adults. If applicable, each skeletal site will be examined by dual energy x-ray absorptiometry (DXA) for classification of the specimens according to the T-score. Via the computation of statistical bone shape models, statistical bone mineral density maps (= 3D BMD maps) of the cortical and cancellous bone will be created using custom-made software algorithms. These maps will comprise statistical meaningful parameters, such as average values and variance, calculated and visualized for each image voxel.

Subsequently, the 3D BMD maps will be transferred into an existing FE environment by directly mapping the density information. For validation of the approach, individually scanned proximal femur specimens will be virtually instrumented with a hip screw and will be tested in an FE environment with regard to stress in the bone structure. Results will be compared with the statistically merged representation of the specimen collective.

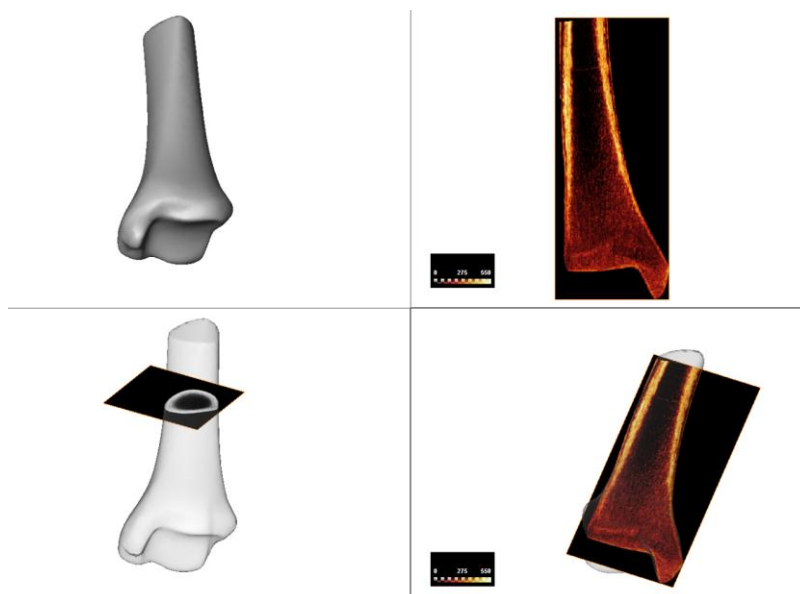

The bone shape in this figure corresponds to the averaged shape of all 54 distal tibiae. The orthoslice (lower left) shows a cross section through the averaged BMD values. Note that each pixel corresponds to an average BMD value of 54 homologous voxels. On the right images the corresponding standard deviation cross sections are visualized by a color map.

#### Pres:

Kamer L. Bone mineral density maps for osteoporosis key regions - technical feasibility. AOTrauma 6th General Meeting Clinical Priority Program, Fracture Fixation in Osteoporotic Bone, May 26–27, 2011 Munich, Germany.

#### Partners:

- Blauth Michael, Prof Dr med, Medical University Innsbruck, Austria

## Human Morphology Services (CT database and 3D bone model project)

Many projects rely on medical image data and 3D computer models of unaffected bones. Acquisition and preprocessing of such data is expensive and time consuming. With respect to ethical and economic reasons it makes sense to reuse data and know-how in different projects, mainly within the AO network. HMS forms a sustainable umbrella project for collecting medical image data, mainly computed tomography (CT) data of unaffected bone, and know how in image processing and analysis for efficient use in related projects. Currently more than 1000 CT data and bone computer models are available. Furthermore there exist several 3D statistical models of bones, such as for the mandible. The use of the data is described in an internal regulation. The database is also registered at 'Eidgenössischer Datenschutz- und Öffentlichkeitsbeauftragter' in Bern.

## Percutaneous computer-assisted screw insertion in the pelvis based on 3-D secure bone corridors

Pelvic and acetabular surgery is one of the most challenging surgeries performed in orthopedic trauma. This includes the complexity of the surgical approach and the risk of iatrogenic lesion of neurovascular structures nearby. Additionally, wide soft tissue dissection leads to secondary complications like thrombosis, rigid scars and periarticular ossification culminating in a significant comorbidity. Hence, the efficacy of the therapeutic approach is a function of limited fracture assessment coupled with advances in surgical exposure and stabilization techniques. The goal of this project is to compute safe SI transverse screw corridors and to establish a workflow for using them for screw navigation in treating non-displaced unstable fractures. The study uses artificial pelvic bones and cadaveric specimens.

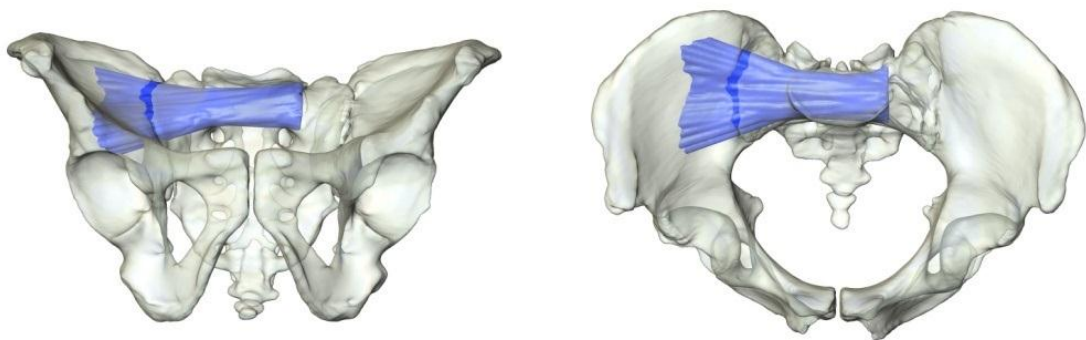

Computation of a general -corridor in the first sacral segment.

### Partners:

- Thomas Mendel, Dr. med., BG-Kliniken Bergmannstrost, Klinik für Unfall- und Wiederherstellungschirurgie, Halle (Saale), Germany
- Ivan Marintshev, DM, Friedrich-Schiller-Universität Jena, Klinik für Unfall-, Hand- und Wiederherstellungschirurgie, Jena, Germany
- Florian Radetzki, Dr. med. Martin-Luther-Universität Halle-Wittenberg, Universitätsklinik und Poliklinik für Orthopädie und Physikalische Medizin, Halle (Saale), Germany
- Lars Bräuer, Dr. med., Martin-Luther-Universität Halle-Wittenberg, Institut für Anatomie und Zellbiologie, Halle (Saale), Germany
- Dietrich Stoevesandt, Dr. med., Martin-Luther-Universität Halle-Wittenberg, Universitätsklinik für Diagnostische Radiologie, Halle (Saale)

## Analysis of an infraacetabular screw corridor – a chance to enhance fixation constructs in acetabular fracture surgery

Fixation techniques in acetabular fracture surgery focus to restore alignment and stability of the anterior and/or posterior column in order to recover acetabular shape. In numerous fracture patterns the placement of an additional screw into the infraacetabular (IA) region connecting both columns below the

acetabular cavity promises higher biomechanical stability in a manner of tension banding. However, this bone region is a part of the so called "dangerous segment". Screws placed at this narrow bone portion parallel to the quadrilateral surface across Köhler's tear drop can easily violate the hip joint. This study was performed to answer the question if a sufficient secure path to place an IA-screw regularly exists in human pelvis.

For this purpose, a 3D radiomorphometric analysis of 125 CT datasets of human pelvis's was performed based on specially computed software scripts. In a standardized workflow the CT raw datasets were post-processed including semiautomatic segmentation with the software "Amira 5.2.2" to obtain 3-D reconstructions. In a next step, the pelvis's were spatially aligned in a standardized coordinate system based on anatomical landmarks. Subsequently, automatic 3-D virtualization of the secure IA-bone corridor for every individual pelvis could be computed by a custom made software algorithm (Fig. 1). Furthermore, this script calculated shape-describing measurement data including volume, size of entry and exit area and coordinates of optimal screw tracks allowing the highest possible safety distance to the cortex within the isthmus region.

In summary, shape analysis revealed a double-cone shaped solid tightly tapered at the level of Köhler's tear drop (Fig. 2). A sufficient infraacetabular corridor for a 3.5 mm-screw existed in 118 of 125 pelvis's (94%). The mean corridor volume amounted 13.3 cm<sup>3</sup> (range: 0.8 – 32.8 cm<sup>3</sup>). The mostly oval screw entry area was 269.2 mm<sup>2</sup> in average (range: 15.7 – 627.2 cm<sup>2</sup>) commonly projecting onto the upper part of the superior pubic ramus including the iliopectineal eminence. A biggest possible screw diameter of 8.5 mm was measured in 5 samples (4%). The limiting factor is the isthmus of Köhler's tear drop. However, it's irregular spatial shape leads to multiple potential tilts of optimal screw tracks throughout the corridor. The entry point as well as the optimal screw vectors can be 3-D visualized. The size of the corridors did show a highly significant difference in gender (p=0.001) with the females having an evidently smaller corridor in the manner of volume as well as the screw entry area. Other correlations to age, height or weight could not be expected.

A one and only optimal screw vector via the IA-corridor does not exist. In fact, a 3.5 mm screw can be tilted in a limited range without loss of safety distance to the cortex within isthmus of a double-cone shaped corridor. The software algorithms programmed within this study allow the 3-dimensional visualization of individual infraacetabular corridors for a 3.5 mm screw. For the computation standard CT raw datasets of human pelvis's can be used. The described workflow allows statistical evaluation and standardized anatomical analyses of pelvis's even of high sample counts. Furthermore, 3-D description of the secure IA bone stock trains the surgeon's visual thinking within preoperative planning of fracture fixation. Finally, the 3-D datasets of the intraacetabular corridors can be stored in a standard DICOM format. Potentially, this allows further application in image guided surgery procedures e.g. navigation. Recently, first experimental handling tests of a CT-based navigation of secure bone corridors in artificial pelvic bone models were performed successfully.

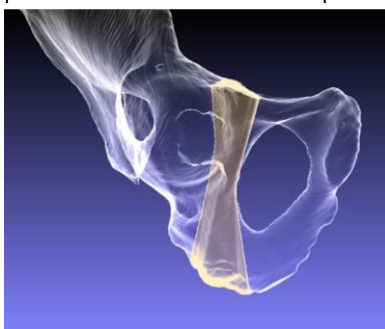

Double-cone shaped 3-D infraacetabular corridor for a 3.5 mm-screw within the iliac bone

**Pres:**

Mendel T, Radetzki F, Noser H, Arlt S, Marintschev I, Hofmann GO: Visualisation sicherer Knochenregionen am Beckenring – Neue Erkenntnisse aus 3-D radiomorphometrischen Untersuchungen. 20. Thüringischer Unfallchirurgisch-Orthopädisches Symposium. Jena, 20.05. – 21.05.2011

### Partners:

- Thomas Mendel, Dr. med., BG-Kliniken Bergmannstrost, Klinik für Unfall- und Wiederherstellungschirurgie, Halle (Saale), Germany
- Ivan Marintshev, DM,, Friedrich-Schiller-Universität Jena, Klinik für Unfall-, Hand- und Wiederherstellungschirurgie, Jena, Germany
- Florian Radetzki, Dr. med. Martin-Luther-Universität Halle-Wittenberg, Universitätsklinik und Poliklinik für Orthopädie und Physikalische Medizin, Halle (Saale), Germany
- Ulf Culemann, Universität des Saarlandes, Homburg, Germany

### Synthesis of a biodegradable scaffold to improve the integration in osteochondral defects and critical size defects in bone (Januscaf) (ongoing)

This project aims to address the repair of osteochondral defects using tissue engineered implants. In particular, the zonal organization of the osteochondral defect; bone and cartilage regions is tentatively recapitulated in the tissue engineering construct with special attention to the vascularization, the mineralization and the bio-active properties of poly(ester-urethanes) surfaces.

The long-term *in vitro* degradation of the poly(ester-urethane) and poly(ester-urethane) / hydroxyapatite scaffolds has been pursued (> 2 year) and the chemical, structural and mechanical properties of poly(ester-urethane) scaffolds recorded showing a monotonous decline of molecular weight, and an increase of the porosity with preserved mechanics up to 16 weeks. Poly(ester-urethane) scaffolds have shown to provide an effective material platform for the study of engineered construct vascularization. It was shown *in vivo* that the establishment of a blood supply to prevascularized poly(ester-urethane) constructs can be accelerated by seeding porous scaffolds with adipose tissue-derived microvascular fragments.

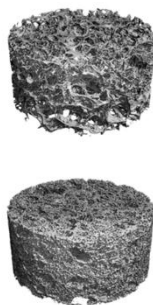
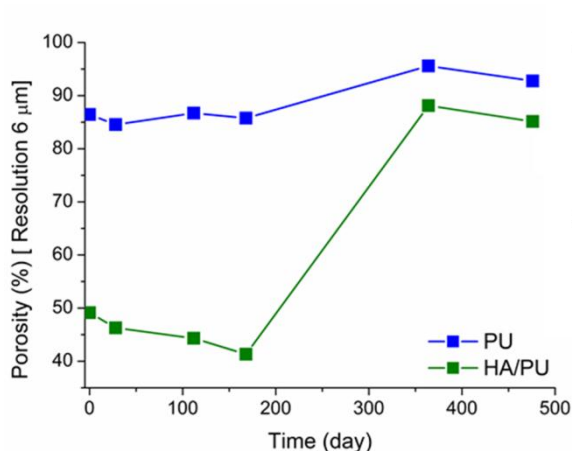

Porosity of poly(ester-urethane) scaffold containing (HA/PU) or not (PU) hydroxyapatite nanoparticles as a function of time in a simulated body fluid as measured microcomputed tomography.

### Pres:

Glamer M, Fliri L, Alini M, Windolf M, Eglin D. *In vitro* degradation of poly(ester-urethane) scaffolds for bone repair. Frontier in Biomedical Polymers Conference, Funchal, Portugal 2011.

Glamer M, Fliri L, Alini M, Windolf M, Eglin D. Poly(ester-urethane) foams for bone repair. An *in vitro* degradation study. Swiss Society for Biomaterials conference, Yverdon-Les-Bains, 2011.

### Pub:

Laschke MW, Mussawy H, Schuler S, Kazakov A, Rücker M, Eglin D, Alini M, Menger MD. Short-term cultivation of *in situ* prevascularized tissue constructs accelerates inosculation of their preformed microvascular networks after implantation into the host tissue. Tissue Eng Part A. 2011;17(5-6):841-53.

### Partners:

- Dr. Matthias Laschke, University of Sarland, Germany
- Prof. Harvey A. Goldberg, University of Western Ontario, Canada



## Modification of titanium (and Ti alloy) surface oxide chemistries to minimize tissue adhesion onto implants destined for removal

Modification titanium oxide surface chemistry on titanium alloys implant allows the modulation of the cell-material interactions via surface chemistry-dependent differences. Several surface treatment techniques for the manipulation of titanium oxide surfaces have been reviewed in term of surface wettability range, stability of the modification, their relevance to industrial process and their effect on osteoblast behavior and osseointegration. Preliminary processing of titanium surface using different treatments has been performed. Cells attachment and morphology were drastically altered on hydrophilic (10°) and hydrophobic (110°) surfaces.

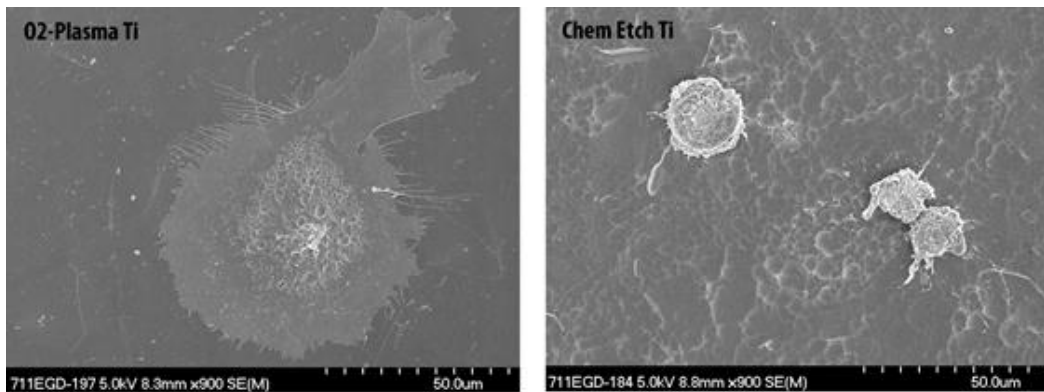

Scanning electron images of modified Titanium surfaces (Oxygen plasma treatment and chemical modification process) after 4h of cell seeding.

### Partner:

- Dr Roman Heuberger, Robert Mathys Stiftung, Switzerland

## To control implant-tissue interactions through implant surface modification (Implantsurf) (Ongoing)

In order to accurately reproduce the clinical situation during fracture repair, more advanced *in vitro* models are required. We have developed a 3 dimensional co-culture system which utilizes a collagen gel base. The addition of hydroxyapatite particles has eliminated the shrinkage normally associated with such culture systems, allowing for cultures to be performed over weeks. We have used this system to investigate the cross-talk signaling that occurs between human mesenchymal stem cells and osteoblast progenitors. We have discovered that the osteoblastic response can be greatly enhanced when co-cultured with MSCs. Using this system, we have also been able to induce calcification in a human preosteoblastic cell line that does not normally calcify. This would suggest that MSCs have a powerful effect on osteoblast development. We aim to use this system to further investigate the effect of various soluble factors on MSC, and osteoblast, behavior and differentiation in a more natural 3D environment. This offers further insights into how these different cell types interact and how we may use this information to develop more suitable cell based strategies in the future.

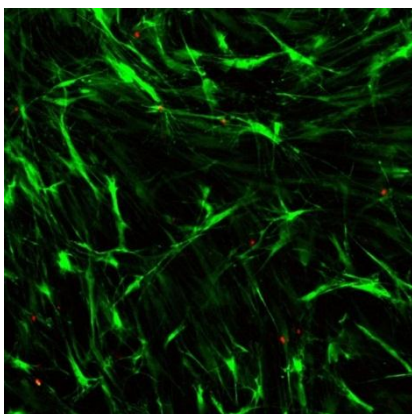

Human MSCs were cultured in a collagen I/ hydroxyapatite gel for 80 days. Staining for live (green) and dead (red) was carried out and demonstrated that most of the cells were still alive and were producing a complex interconnected network.

**Pres:**

Czekanska, E. M.; Stoddart, M. J.; Hayes, J. S.; Ralphs, J. R.; Richards R. G. Evaluation of osteoblast cell models used in orthopedic related research. Orthopedic Research Society Annual Meeting, 13 - 16 January 2011, Long Beach CA USA

**Partner:**

- Dr Jim Ralphs, Cardiff Institute of Tissue Engineering and Repair, School of Biosciences, Cardiff University, Wales, United Kingdom

**Development of clinically relevant animal models for investigating musculoskeletal Infections; their treatment, prevention and diagnosis (Infect-fx).**

Musculoskeletal infection is one of the most common complications associated with surgical fixation of bones fractured during trauma. In order to more accurately mimic the clinical situation the current project is developing a fracture model that will allow assessment of the impact of infection on fracture healing and allow evaluation of novel interventional strategies in a clinically relevant model.

A custom made femoral nail was developed in collaboration with the innovations group and the preclinical surgery group. The first pilot trials of this femoral nail proved to have higher than desirable complications with some stress fractures and failures observed. Good histological healing was observed in the successful trials and mechanical test results showed that the healed bone had similar mechanical properties as the healed bones fixed with commercially available locking plates. Nevertheless, to minimize the risk of further failures we decided to move to a humeral model to reduce the forces applied to this bone and implant. A custom made humeral nail was developed and the first trials with this new nail shall be performed in 2012. Additionally, a classification scheme for IM nail related osteomyelitis was developed and evaluated. Eventually, these models will be suitable for modeling infection prevention, treatment and diagnosis studies at ARI and externally.

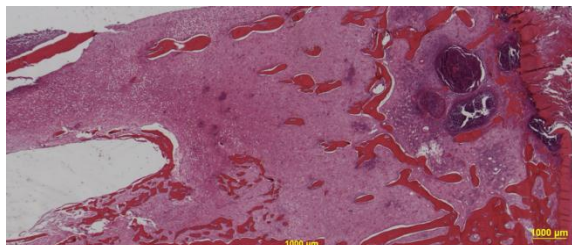
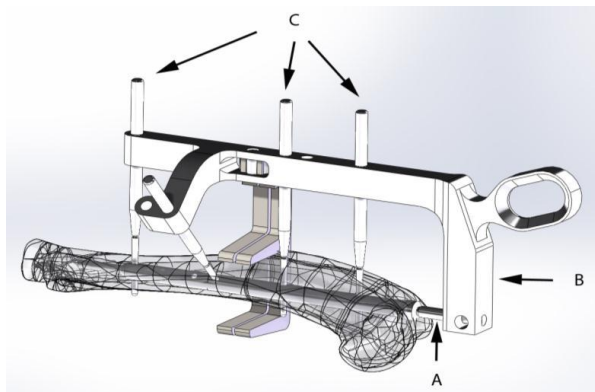

Histological section of an infected rabbit tibia (left) serving as a model for the development of a classification scheme for infection. The new humeral nail (right) showing custom fit to the rabbit humerus.

**Pub:**

Preclinical animal models in trauma research. Harvey EJ, Giannoudis PV, Martineau PA, Lansdowne JL, Dimitriou R, Moriarty TF, Richards RG. J Orthop Trauma. 2011 Aug;25(8):488-93

**Title: Development of new agents for the specific diagnostic imaging of infections associated with orthopedic devices (Imagin)**

Our infection imaging project aims to improve diagnosis of infection by combining newly developed infection probes with functional imaging modalities. Current clinical gold standard methods target both septic (infectious) and aseptic conditions. We have found that bacteriocins, which are bacteria produced molecules designed to specifically target other bacteria, display promising infection diagnostic potential. The bacteriocins have been labeled with dyes and exposed to *Escherichia coli*, *Staphylococcus aureus*, *Staphylococcus epidermidis*, and *Pseudomonas aeruginosa* and detected by Flow cytometry. Thus far we have identified bacteriocins that specifically identify Gram positive bacteria. These molecules have also been found to be non-toxic to host cells. Furthermore a two-step labeling procedure has been

developed which allows an increase in signal and also allows improved delivery of probes to the target bacteria. This procedure in combination with bacteriocins will be used in the first pilot study in 2012.



Improved diagnostic imaging of infection would greatly improve patient care.

**Pub:**

I Potapova, TF Moriarty, RG Richards. Bacteriocins as Gram-specific infection probes. 2011 World Molecular Imaging Congress. September 7-10, 2011 / San Diego, California

I Potapova, TF Moriarty, RG Richards. Bacterial peptides as imaging probes for functional imaging in infection diagnostics. eCM XII Implant Infection, Davos June 22-24 2011.

**Partner:**

- Alberto Signore, University la Sapienza, Rome, Italy

**Investigating the molecular epidemiology of *Staphylococcus aureus* isolates from musculoskeletal infections associated with internal fracture fixation devices. (Staphtyp)**

The aim of this study is to identify clonal structure of *Staphylococcus aureus* isolated from infections surrounding fracture fixation devices and survey the most prevalent virulence factors possessed by these organisms. Bacterial isolates have been collected from Hospitals and University departments in Zurich, Liestal, Luzern and Freiburg in Switzerland. The project has now been expanded to trauma and infection centers from Germany, Austria, France and the United States. The collection of *Staphylococcus epidermidis* has now also begun in Germany. With increasing number of isolates (over 250 isolates as of 2011) the identification and characterization of most prevalent strain types is beginning to provide information as to the role of specific virulence factors crucial for the pathogenesis of these infections.

**Pub:**

V Post, TF Moriarty, RG Richards. Characterization of staphylococcus aureus from orthopedic device related infections. eCM XII Implant Infection, Davos June 22-24 2011

**Partner:**

- Magnus Höök, Texas A&M University Health Science Center, USA
- Peter Wahl, Cantonal Hospital Freiburg, Switzerland
- Werner Zimmerli, Liestal Switzerland

**The Effect of Stainless Steel Schanz Pins Topography on Bone and Soft Tissue Integration: a Loaded External Fixator Fracture Model in Sheep (ExFixSurf-AOTrauma Feasibility)**

The most commonly encountered complications associated with external fixation are pin loosening and pin tract infection (PTI). Insertion techniques can be source of thermal and mechanical damage of the bone during pin insertion, micro-motion at the pin site and formation of fibrous tissue at the tissue-pin interface have been identified as the main causes of pin loosening and infection. In this project we are aiming to reduce infection rate by improving soft and hard tissue integration to Schanz screws by providing surfaces optimal for integration. Prototype novel microrough stainless steel Schanz screws were prepared in collaboration between the Infection group and Tissue Morphology group. Theses Schanz screws have been characterized and a pilot sheep study was performed where the novel screws were placed in 6 sheep. Histological analysis is still ongoing, and must be completed before the final report

on the feasibility study shall be presented. This project was approved by AOTRC in December 2011 for commencement in 2012.

### Assessing the Role of the Implant Mediated Immune Response on the Development of Infection (Immunobact- AOTrauma feasibility)

Different materials can influence the immune response upon implantation. The *in vivo* reaction to an implant may then influence infection susceptibility due to an altered immune response. Screening of the immune response to a broad range of clinically relevant biomaterials was conducted *in vitro*. From this it appears that titanium may be a relatively immunosuppressive material whilst polyetheretherketone may more readily prime immune cells and induce more reactive responses. To investigate this trend further and investigate the effect of this difference on infection an *in vivo* model is required to integrate the many complex aspects of the immune system. As a result of this feasibility study, we have applied to AOTrauma for a full project application to allow investigation of the role of implant material in a mouse model. The results of this study will be combined with the *in vitro* work to identify the key features of implant associated immune responses that affect the outcome of infection in trauma surgery.

#### Pub:

ETJ Rochford, TF Moriarty, RG Richards, AHC Poulsson. An *in vitro* study of bacterial adhesion to oxygen plasma treated PEEK. eCM XII Implant Infection, Davos June 22-24 2011

E.T.J. Rochford, T.F. Moriarty, R.G. Richards, A.H.C. Poulsson. The Effect of Surface Modifying PEEK to Improve Osseointegration on Bacterial Adhesion *in vitro*. European Society for Biomaterials Conference Dublin Ireland 2011.

#### Partner:

- Liam O' Mahony, SIAF Davos. Switzerland

## AOSpine

### Development and proof of concept of monopedicular irrigation for improved vertebroplasty (Augtech-Spine)

Problem: Previous in-vitro and in-vivo investigations, revealing a clear potential of irrigation procedures, accompanying vertebroplasty, to reduce the risk of cardiopulmonary reactions and fat embolisms, involved a bipedicular approach, where pulsed jet-lavage was performed via one of the pedicles and suction of the fluid via the other, thus causing additional trauma. Goal: To develop a prototype system for monopedicular irrigation in vertebroplasty and prove the concept in terms of handling, function and performance. Results: An in-vitro test model including evaluation method was developed to perform parametric analyses on the fat removal capabilities of several monopedicular approaches. The functionality of a prototype system was proven by use of the test model.

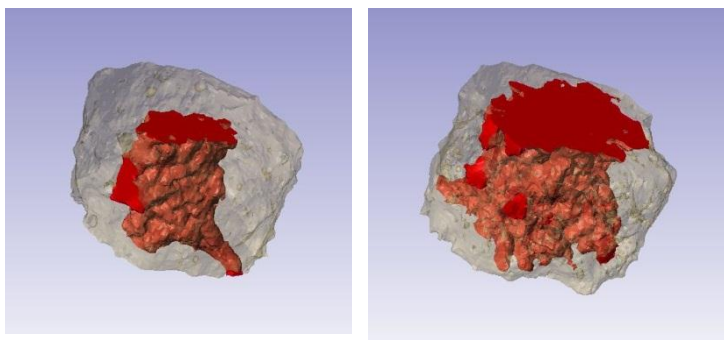

#### Partner:

- Benneker L, Department of Orthopedic Surgery, Inselspital, Bern, Switzerland

## Graft Integration in the Lumbar Spine of Bovine Cancellous Bone Compared to Autologous Iliac Crest in a Sheep Model (Spinlock) (Completed)

Ventral spondylosis using an autologous iliac crest transplant is a common procedure in clinical routine for stabilization of the spine in humans. However, there is a certain risk for graft failure, reflected by a certain fracture rate. Therefore, this study evaluated the effect of the graft size on the failure risk in a prospective sheep model and a retrospective human study. The sheep model using an implanted graft between L3/4 (autologous iliac crest and ventral plate fixation) was chosen because of the biomechanical comparability of the sheep spine with the one of humans. CT scans were performed after surgery on animals as well as on humans several months after surgery. In the prospectively planned sheep model (n=8), the CT scans were performed approx. 6 months after surgery. The retrospective CT evaluation of human patients (n=82) was performed 4–12 months after surgery. Graft and endplate areas were measured performing morphometric planimetry using radiological software and ratios were calculated. In addition, in the sheep model, the sagittal reconstruction of the graft was histologically assessed for fractures and osteolysis. In sheep, all grafts with a cross-sectional ratio smaller than 21% fractured (n=3/8). In humans, the risk of graft fracture was lower than 0.1% if the graft ratio exceeds 23.9% (see figure). This study clearly showed that the graft/endplate ratio has a significant influence for midterm stability and clinical healing. Furthermore this investigation could show that the results of the sheep model can successfully be transferred to the clinical situation of human patients.

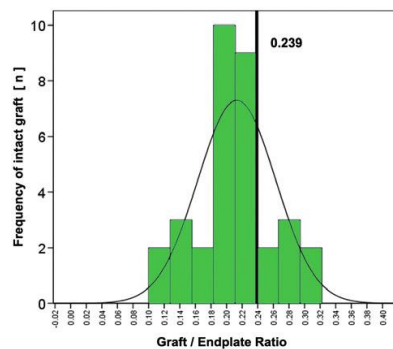
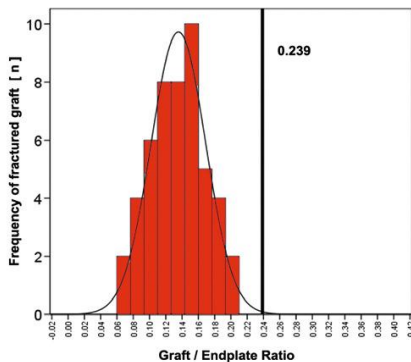

Distribution of ratio values for fractured (left red) and intact (right side, green) grafts. The risk of graft fracture is only 0.1% ( $p < 0.001$ ) if the graft/endplate ratio is 0.239. In the present study, the ratio values were  $< 0.239$  for 69.5% of all intact grafts

### Pres:

Kubosch D, Milz S, Bley TA, Sprecher CM, Südkamp NP, Strohm PC. Die Diagnose des Transplantatversagens bei der ventralen lumbalen Spondylose: Eine Frage der Auflösung, demonstriert am Xtreme-CT. 71. Jahrestagung der Deutschen Gesellschaft für Unfallchirurgie & Deutscher Kongress für Orthopädie und Unfallchirurgie (DKOU) 24.-27. Oktober 2007, ICC Berlin Poster P18-712 (Best Presentation - Sitzungspreis der Wirbelsäulensitzung, P18-2581)

Kubosch D, Milz S, Sprecher CM, Südkamp NP, Strohm PC. Transplantatversagen bei der ventralen Spondylose – Eine Frage der Transplantatgröße? 3. Deutscher Wirbelsäulenkongress, Jahrestagung der Deutschen Wirbelsäulengesellschaft, Ulm, 27. - 29. November 2008; V 52 (lecture), Abstracts published in European Spine Journal 2008

Kubosch D, Konstantinidis L, Lohrmann C, Milz S, Südkamp NP, Strohm PC. Spanfrakturen der dorso-ventralen lumbalen Spondylose: ein Problem der Spangröße? DKOU 21-24.10.2009 Berlin; WI38-940.

### Poster:

Kubosch D, Milz S, Bley T, Sprecher C, Südkamp N, Strohm P. Spanfrakturen bei der ventralen lumbalen Spondylose: Ein vermeidbares Problem? 72. Jahrestagung der Deutschen Gesellschaft für Unfallchirurgie & Deutscher Kongress für Orthopädie und Unfallchirurgie 22.-25. Oktober 2008, ICC Berlin (Poster) PO20-1231

Strohm PC, Rohr J, Reising K, Südkamp NP. Vergleich der knöchernen Einheilung von autologem Beckenkammspan mit boviner Spongiosa bei der ventralen Spondylose der LWS im Schafsmodell durch CT DKOU 21-24.10.2009 Berlin; PO11-1384

### Pub.:

Strohm PC, Kubosch D, Bley TA, Sprecher CM, Südkamp NP, Milz S. Detection of bone graft failure in lumbar spondylodesis: spatial resolution with high-resolution peripheral quantitative CT. *AJR Am J Roentgenol.* 2008 May;190(5):1255-9.

Kubosch D, Milz S, Sprecher CM, Südkamp NP, Müller CA, Strohm PC. Effect of graft size on graft fracture rate after anterior lumbar spinal fusion in a sheep model. *Injury.* 2010 Jul;41(7):768-71. Epub 2009 Sep 8.

Strohm PC, Kubosch DC, Sprecher CM, Schmal H, Südkamp NP, Milz S. [Graft integration in the lumbar spine of bovine cancellous bone compared to autologous iliac crest in a sheep model]. *Z Orthop Unfall.* 2010 Dec;148(6):666-73. Epub 2010 Jul 20.

Kubosch D, Milz S, Lohrmann C, Schwieger K, Konstantinidis L, Sprecher CM, Südkamp NP, Strohm PC. Risk of graft fracture after dorso-ventral thoraco-lumbar spondylodesis: is there a correlation with graft size? *Eur Spine J.* 2011 Oct;20(10):1644-9. Epub 2011 Jul 12.

### Prizes:

- Innovationspreis der DGU 2010:  
Einfluß der Span-/Deckplattenrelation auf das Transplantatversagen bei der ventralen Spodylodese mit autologem tricorticalen Beckenkammspan
- Sitzungspreis Postersession Wirbelsäule DKOU 2009 Berlin:  
Vergleich der knöchernen Einheilung von autologem Beckenkammspan mit boviner Spongiosa bei der ventralen Spondylodese der LWS im Schafsmodell durch CT
- Kurt-Steim-Preis der medizinischen Fakultät der Albert-Ludwigs-Universität Freiburg 2009:  
Die Diagnose des Transplantatversagens bei der ventralen lumbalen Spondylodese: Eine Frage der Auflösung demonstriert am Xtreme-CT
- Sitzungspreis Poster Session Wirbelsäule DKOU 2007 Berlin:  
Die Diagnose des Transplantatversagens bei der ventralen lumbalen Spondylodese: Eine Frage der Auflösung, demonstriert am Xtreme-CT

### Diss:

Kubosch D, Die Diagnose des Transplantatversagens bei der ventralen lumbalen Spondylodese Eine Frage der Auflösung demonstriert am Xtreme-CT; Albert-Ludwigs-Universität Freiburg 2008

### Habil:

Strohm PC, Vergleich des Einwachsverhaltens von tricortikalen Beckenkammspanen und lösungsmittelkonservierter, boviner Spongiosa bei ventralen Spondylodesen der Lendenwirbelsäule im Schafsmodell; Albert-Ludwigs-Universität Freiburg 2008

### Partners:

- Strohm PC, Kubosch DC, Südkamp NP, Department für Orthopädie und Traumatologie, Klinikum der Albert-Ludwigs-Universität Freiburg, Germany
- Milz S, Anatomische Anstalt der Ludwig-Maximilians-Universität München, Germany

### Surface modification of PEEK to improve tissue integration (Peeksurf) (ongoing)

Polyetheretherketone (PEEK) has come to the forefront in the field of biomaterials as a radiolucent replacement for metals in devices such as spine cages and patient specific craniomaxillofacial implants, due to its high strength and good wear properties compared to polymers such as UHMWPE. As PEEK is radiolucent it allows the region of interest to be visualized to allow the tissue integration to an implant to be evaluated. PEEK has an intrinsic low surface energy, which can limit cellular adhesion and this can in turn lead to implant loosening as a result of fibrous encapsulation. The surface of PEEK can be altered by plasma modification to increase the surface energy and thereby improve cellular adhesion in order to avoid implant loosening. An ongoing *in vivo* study is aiming to demonstrate and assess the translational potential of the proposed surface modification.

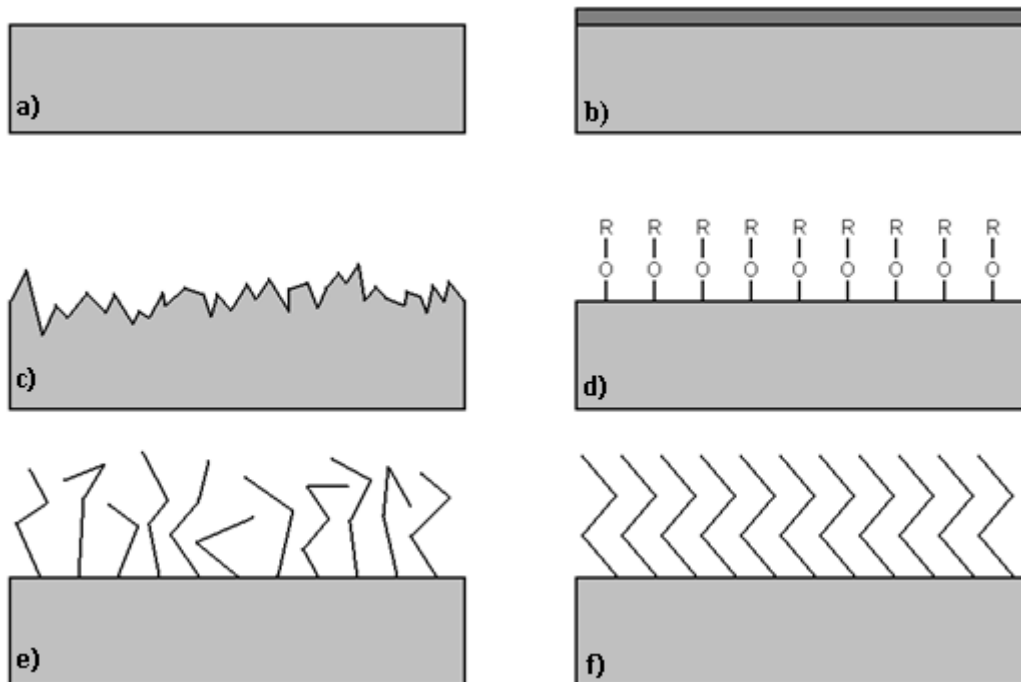

Schematic representation of resulting surface from various surface modification techniques, a) original surface, b) coated surface, c) etched surface, d) chemically functionalized surface, e) grafted surface, f) self-assembled monolayers (from Poulsson et al. 2011).

#### Pres:

Poulsson AH, Richards RG Stable oxygen plasma surface modification of PEEK to improve osteoblast cytocompatibility. 2011. SFB.

Poulsson AH, Richards RG. Improving Human Primary Osteoblast Interactions to PEEK by Surface Modification. 2011. ORS.

Poulsson AH, Rochford ET, Moriarty TF and Richards RG. Plasma Surface Modification of PEEK: Effects on Osteoblast Cytocompatibility and Bacterial Adhesion. 2011 MD&M West. (Invited speaker)

Poulsson AH, Richards RG. Improving osteoblast cytocompatibility of PEEK by a stable oxygen plasma surface modification. 2011. ESB.

Brady M, Poulsson AH, Wilson J, Eglin D, Richards RG, Jarman-Smith M Mechanical properties and bioactivity of PEEK-OPTIMA®/Hydroxyapatite compounds. 2011. SFB.

Rochford ET, Moriarty TF, Richards RG, Poulsson AH. *In vitro* bacterial adhesion to PEEK tailored for osseointegration by surface modification. 2011. SSB.

Rochford ET, Moriarty TF, Richards RG, Poulsson AH. *In vitro* bacterial interactions with surface modified PEEK. 2011. SCBMI.

Rochford ET, Moriarty TF, Richards RG, Poulsson AH. The effect of surface modifying PEEK to improve osseointegration on bacterial adhesion *in vitro*. 2011. ESB.

Rochford ET, Subbiahdoss G, Moriarty TF, Poulsson AH, van der Mei HC, Busscher HJ, Richards RG Co-culture Adhesion of Bacteria and Osteoblasts to Oxygen Plasma Treated PEEK. 2011. ORS.

Rochford ET, Subbiahdoss G, Moriarty TF, Poulsson AH, van der Mei HC, Busscher HJ, Richards RG Plasma surface modification of PEEK - Effects on bacterial adhesion and co-culture with osteoblasts *in vitro*. 2011. SFB.

**Pub:**

A.H.C. Poulsson, R.G. Richards. Surface Modification Techniques of PEEK; Including Plasma Surface Treatment . In: Kurtz S.M., editor. PEEK Handbook. Elsevier; 2011, In Press.

E.T.J. Rochford, D.J. Jaekel, N.J. Hickok, R.G. Richards, T.F. Moriarty, A.H.C. Poulsson. Bacterial Interactions with PEEK. In: Kurtz S.M., editor. PEEK Handbook. Elsevier; 2011, In Press.

**Survival and Differentiation of Bone Marrow Derived Mesenchymal Stem Cells into Disc Cells when Injected into an Intervertebral Disc Organ Culture System (Discfreq) (Ongoing)**

Mesenchymal stem cells (MSCs) have shown potential for intervertebral discs (IVD) regeneration. MSC survival and differentiation is strongly affected by the IVD environment, which is hypoxic and displays low glucose concentration and pH. A potential technique to improve MSC fate in the disc is MSC pre-differentiation with appropriate carriers and growth factors. Thermoreversible hydrogels are advantageous as cells can be collected after pre-culture by cooling and then injected in the IVD. We investigated whether pre-culture was necessary to improve MSC fate when supplied with our recently developed hyaluronan-based thermoreversible hydrogel carrier in IVDs. Nucleotomies were performed on bovine caudal discs with endplates. Fluorescence labeled human MSCs were suspended in the thermoreversible hydrogel and injected into the IVDs. For the differentiation study, MSCs were either suspended in the thermoreversible hydrogel and directly supplied to nucleotomized IVDs or pre-differentiated for one week in the thermoreversible hydrogel and then supplied to the IVDs. MSCs viability was preserved when cultured ex-vivo in the thermoreversible hydrogel; MSCs differentiated towards a disc-like phenotype, as shown by the up-regulation of collagen type-II, keratin-19 and CD24. Pre-culture of MSCs did not enhance MSC differentiation in the IVDs under the chosen conditions. To conclude, direct application with the hyaluronan-based thermoreversible hydrogel carrier can promote MSC differentiation in an organ culture model. The finding that no pre-culture is needed implies strong cost and time savings for MSC-based therapies of IVD diseases.

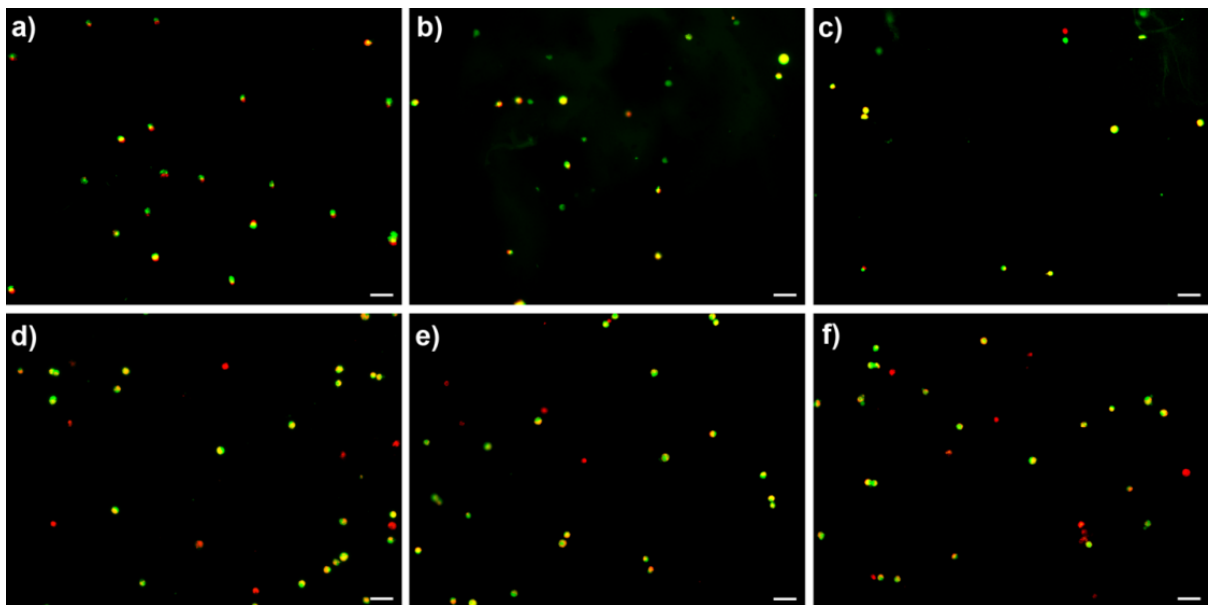

Calcein AM staining of PKH26 labeled hMSCs in punched bovine IVD in: HA-pNIPAM hydrogel at a) day 1, b) day 3, c) day 7; alginate control at d) day 1, e) day 3, f) day 7. Yellow = live hMSC cell; red = dead hMSC or disc cell; green = live disc cell.

**Pres.:**

Peroglio M, Eglin D, Grad S, Alini M. Assessment of Nucleus Pulposus Cell Phenotype Cultured in Thermoreversible Hyaluronan-based Hydrogels. ORS 2011, Long Beach, USA (Poster).



Peroglio M, Eglin D, Sprecher CM, Illien-Jünger S, Grad S, Alini M. Thermoreversible Hyaluronan-based hydrogels for nucleus pulposus tissue engineering. TERMIS 2011, Granada, Spain (Oral).

Peroglio M, Eglin D, Sprecher CM, Illien-Jünger S, Grad S, Alini M. Viability, Glycosaminoglycan Synthesis and Phenotype of Nucleus Pulposus Cells in Thermoreversible Hydrogel. ESB2011, Dublin, Ireland (Poster).

Grad S, Stoddart MJ, Lezuo P, Alini M. Mimicking the physiological environment to engineer and study articular cartilage and intervertebral disc. International Conference on Tissue Engineering 2011, Chania, Crete.

Pattappa G, Illien-Jünger S, Peroglio M, Grad S, Alini M. Mesenchymal stem cell homing is influenced by soluble mediators from stressed intervertebral discs with or without end-plate. ISSLS 2011, Gothenburg, Sweden.

#### **Pub.:**

Gantenbein-Ritter B, Sprecher CM, Chan SCW, Illien-Jünger S, Grad S. Confocal imaging protocols for live/dead staining in 3-dimensional carriers. *Methods Mol Biol.* 740:127-40, 2011.

Collin E, Grad S, Zeugolis D, Guicheux J, Weiss P, Alini M, Pandit A. An injectable vehicle for nucleus pulposus cell-based therapy. *Biomaterials* 32(11):2862-70, 2011

Peroglio M, Grad S, Mortisen D, Sprecher CM, Illien-Jünger S, Alini M, Eglin D. Injectable thermoreversible hyaluronan-based hydrogels for nucleus pulposus cell encapsulation. *Eur Spine J* 2011 (Epub ahead of print)

#### **Partners:**

- Prof. D. Sakai, Tokai University School of Medicine, Japan
- Prof. J. Mochida, Tokai University School of Medicine, Japan
- Prof. A. Pandit, National University of Ireland, Galway
- Dr. L. Benneker, University Hospital Bern, Switzerland

## **AOCMF**

### **Workflow for custom-made CAD/CAM titanium plates based on virtually planned maxillofacial reconstruction**

Maxillofacial defects caused by trauma, tumor resection or malformation requires complex 3D functional and aesthetical reconstruction. The postoperative result is dependent on the meticulous preoperative planning and its transfer to surgery. One of the latest techniques represents the prefabrication of fibula flaps, which includes reconstruction of occlusion, bone and soft tissue based on a physical 3D model planning (i.e. Rapid Prototyping models). They provide the most accurate technique allowing for complete functional reconstruction with the best fitting of drilling templates, occlusal splints, suprastructure and individual osteosynthesis plates.

Computer-assisted virtual planning could on one hand replace existing 3D planning and would on the other hand improve the adaptation and accuracy of fit of custom-made reconstruction plates. We propose a new workflow to treat such patients. It includes preoperative image data acquisition, processing and analyzing the data and the development of surgeon driven software procedures. Then the planning procedure will then undergo Computer-Aided Design/Computer-Aided Manufacturing (CAD/CAM) processes resulting in the production of a custom-made titanium plate. This plate will act as an accurate intraoperative guidance and fixation device - thus helping the surgeon to obtain a good surgical result. The following milestones will be included in the study: a) matching of skull and fibula Computed Tomography (CT) data b) virtual planning of a new occlusion c) evaluation and determination of the size, osteotomies and alignment of the fibula flap within the defect d) planning of an individually designed reconstruction plate e) transfer of the data to a production unit

In a first attempt the feasibility will be tested on a virtual patient. It will also include the evolution of different CAD/CAM techniques. In a second attempt given clinical cases will be treated using the newly developed planning software in combination with the unit that allows for the production of custom made plates.

**Pres:**

Kamer L, Rohner D et al. Workflow for custom-made CAD/CAM titanium plates based on virtually planned maxillofacial reconstruction. AOCMF 1st Workshop Clinical Priority Program (CPP) Imaging and Planning of Surgery, May 5, 2011 Freiburg, Germany

**Partners:**

- Dennis Rohner, PD Dr.med. Dr.med.dent. Cranio-Facial Center (cfc) Hirslanden, Aarau, Switzerland
- Beat Hammer, Prof. Dr.med. Dr.med.dent. Cranio-Facial Center (cfc) Hirslanden, Aarau, Switzerland
- Christoph Zizelmann, Dr.med. Dr.med.dent. Cranio-Facial Center (cfc) Hirslanden, Aarau, Switzerland

**Evaluation of accuracy of CAD/CAM fabricated splints for orthognathic surgery**

The clinical outcome in orthognathic surgery depends critically on accurate preoperative planning. The need for 3D preoperative assessment has been documented over the past years and conventional planning has been added by a 3D computerized approach. Until now, these techniques have mainly been used in single cases, i.e. in complex asymmetric cases and not in routine clinical practice. Computer-assisted virtual planning could on one hand replace existing conventional planning and model surgery and would on the other hand improve the accuracy of the clinical outcome.

In conventional as well as in virtual approaches, surgical splints are usually used for transferring the surgical plan to the patient. Conventional splints are manufactured on the plaster cast models, whereas in computerized approaches this is achieved using CAD/ CAM (Computer-aided design/ Computer-aided manufacturing) techniques (i.e. manufactured Rapid Prototyping techniques). However, there it is still controversy concerning the best approach to manufacturing of accurate CAD/ CAM splints.

The goal of the present study is to define a suitable workflow to produce CAD/ CAM splints in orthognathic surgery. To obtain an accurate virtual model of the dental surfaces, different radiological and surface scan modalities will be assessed. The different processing steps will be evaluated and then combined with the most suitable Rapid Prototyping manufacturing technique and material respectively. Finally, these splints will be compared with conventional manufactured splints (gold standard). The best manufacturing process will be integrated into computerized planning procedures of clinical cases.

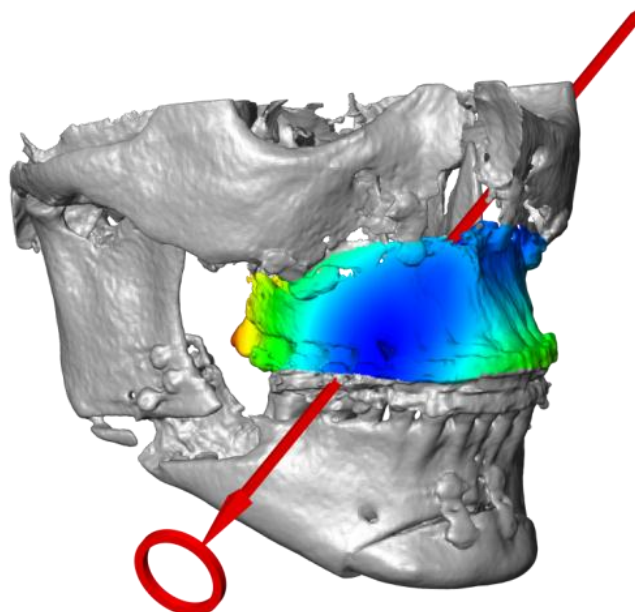

Development of a three-dimensional workflow to analyze the surgical outcome: The position of the maxilla from the planning stage is compared with the postoperative control.

## Pres:

Zizelmann C. Evaluation of accuracy of CAD/CAM fabricated splints for orthognathic surgery AOCMF 1st Workshop Clinical Priority Program (CPP) Imaging and Planning of Surgery, May 5, 2011 Freiburg, Germany.

## Partners:

- Christoph Zizelmann, Dr.med. Dr.med.dent., Cranio-Facial Center (cfc) Hirslanden, Aarau, Switzerland
- Dennis Rohner, PD Dr.med. Dr.med.dent., Cranio-Facial Center (cfc) Hirslanden, Aarau, Switzerland
- Beat Hammer, Prof. Dr.med. Dr.med.dent., Cranio-Facial Center (cfc) Hirslanden, Aarau, Switzerland
- HH Horst Kokemueller, PD Dr.med. Dr.med.dent., Oral and Maxillofacial Surgery, Hannover Medical School, Hannover, Germany

## AOVET

### Evaluation of Slocum TPLO plates retrieved from dogs with peri-implant osteosarcoma and non-affected animals. (Vetplate) (Ongoing)

Tibial plateau leveling osteotomy (TPLO) in veterinary surgery is a commonly used procedure to treat cranial cruciate ligament ruptured in dogs. An unusual accumulation of peri-implant osteosarcoma was observed in dogs treated with Slocum cast stainless steel TPLO plates (Fig). It was postulated that the metallurgical inhomogeneity of the plate surface, or the corrosion properties of the cast stainless steel material itself, were related to this observation.

Micro electrochemical corrosion tests were performed at randomly chosen spots located on the plate surface that had contact to the underlying bone. The local corrosion measurement results showed a wide variation within each plate and between plates. Especially on undesired surface alterations (i.e. artifacts created during plate contouring) reduced corrosion behavior was observed. Contouring of cast plates clearly alters the local corrosion resistance and reduces the electrochemical breakdown potential considerably.



Radiograph of an operated dog knee with a large lysis zone (surrounded by a dotted line) in the tibia beneath the Slocum TPLO plate (left) and a contoured and explanted TPLO plate visualized from the bone (middle) and the soft tissue side (right).

## Partners:

- RJ Boudrieau, Cummings School of Veterinary Medicine, Tufts University, North Grafton, USA.
- T Suter, EMPA, Swiss Federal Laboratories for Materials Science and Technology, Dübendorf, Switzerland
- S Milz, Anatomische Anstalt der Ludwig-Maximilians-Universität München, Germany

## AOTK

### Histomorphological Analysis of Shoulder Resurfacing Arthroplasty (ShouCap) (Ongoing)

Shoulder resurfacing arthroplasty is designed to restore the function of the shoulder with less trauma than stemmed shoulder arthroplasty. At the same time it attempts to conserve a maximum of the humeral bone stock in order to ease a potential revision. Currently several resurfacing designs from different manufactures, most of them with cementless anchorage, are available. Several studies have reported about good clinical results. However, some studies and also data from the Australian Joint Register indicate a higher number of revisions for resurfacing implants. Therefore the present study evaluates the osseous integration of shoulder resurfacing implants. Explanted human shoulder resurfacing implants are collected and evaluated by histomorphological analysis (bright field light microscopy, microradiography and scanning electron microscopy). Analysis is performed with respect to the amount of bone under the resurfacing implant and for the osseous integration at the bone/implant interface. The results should provide a better understanding of the osseous integration and stability of the resurfacing implants as well as the bone remodeling processes under the implant.

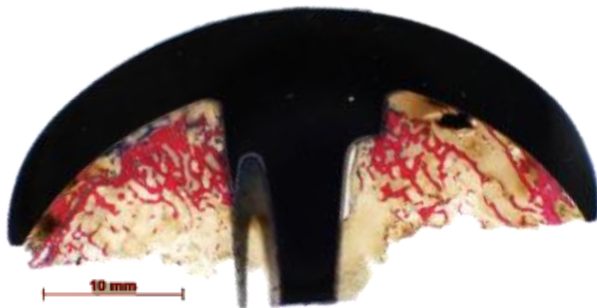

#### Partners:

- Braunstein V, Dr. med., Ludwig-Maximilian-University (LMU) Munich, Klinikum Innenstadt Chirurgische Klinik u. Poliklinik, München, Germany
- Suedkamp NP, Prof. Dr. med., Direktor Department of Orthopedic and Trauma Surgery Universitätsklinikum der Albert-Ludwigs-Universität, Freiburg, Germany
- Hertel R. Prof. Dr. med., Lindenhofspital, Bern, Switzerland

### Biomechanical Evaluation of Three Different Locking Options Using MultiLoc PHN for Intramedullary Nailing of Proximal Humerus Fractures in a Three Part Fracture In-Vitro Model

Problem: The treatment of unstable three and four part proximal humerus fractures still remains challenging. Clinical outcomes using standard osteosynthesis treatments are not yet satisfactory especially in osteoporotic bone. That is why optimization of the implant design accounting for healthy and osteoporotic bone is of major interest. An extended version of MultiLoc PHN intramedullary nail was recently developed for simple and complex proximal humerus fractures. In addition to the possibility for multiplanar distal fixation with two angle-stable locking screws (ASLS) and three proximal humeral head screws (standard), this nail introduces the screw-in-screw concept including one additional locking screw in each of the proximal screws. Further on, a calcar screw starting in the lateral cortex of the shaft and ending in the cancellous bone of the humeral head calcar region can be optionally placed. The purpose of these design adaptations is to improve implant anchoring to bone and support the head fragment thereby increasing construct stability.

Goal: To investigate biomechanically three different locking options using MultiLoc PHN (short) for intramedullary nailing of proximal humerus fractures and answer the question whether its design

adaptations with two additional screw-in-screw and a calcar screw provide a better interfragmentary stability compared to the standard version with three proximal screws in an established human anatomic biomechanical three part proximal humerus fracture model.

Results: The MultiLoc PHN with a calcar screw plus two screw-in-screw showed a superior initial axial construct stiffness, minimal axial displacement, reflecting highest head stability against migration along the nail, and highest number of cycles to failure. In addition, both options with two screw-in-screw, aiming volumes in the posteromedial humeral part with better bone quality, were superior with regard to varus tilting of the humeral head, compared to the standard configuration.

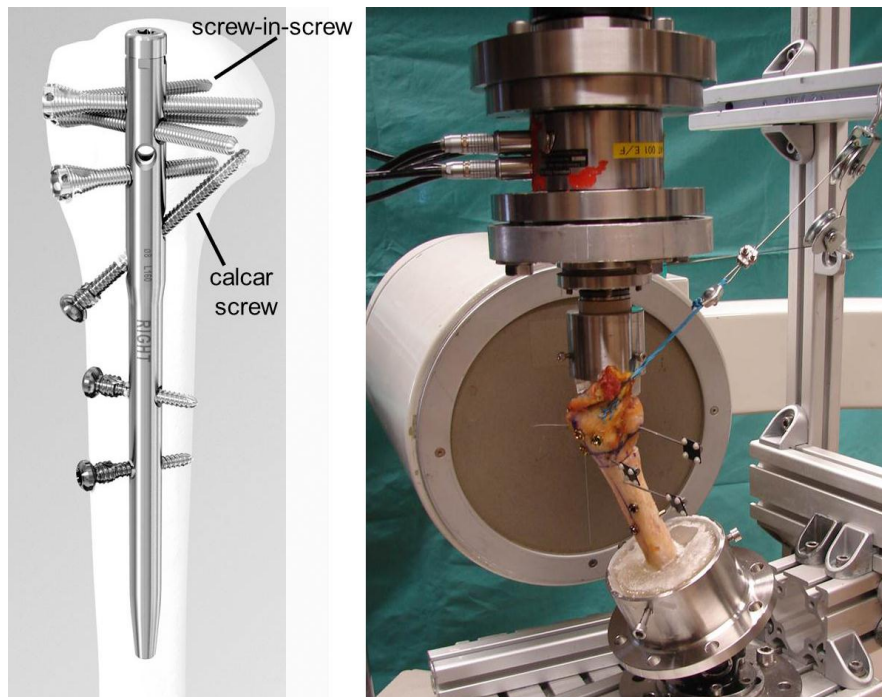

#### Pub:

Rothstock S, Plecko M, Kloub M, Schiuma D, Windolf M, Gueorguiev B. Biomechanical evaluation of two intramedullary nailing techniques with different locking options in a three-part fracture proximal humerus model. Clin Biomech (2012) doi: 10.1016/j.clinbiomech.2012.03.003

#### Partners:

- Michael Plecko, MD, University Hospital Zurich, 8091 Zurich, Switzerland
- Stefaan Nijs, MD, PhD, UZ Leuven, 3000 Leuven, Belgium
- Martin Kloub, MD, Hospital Ceske Budejovice, 37001 Ceske Budejovice, Czech Republic

#### Development of a standardized computational testing model for the proximal humerus (HumFE) (ongoing)

Problem: Fixation failure rates at the proximal humerus remain high, particularly in osteoporotic bone. Goal: To establish a computational testing model for new implant designs and concepts to systematically improve the performance of fixation hardware and in long-term to solve the fixation problem at the proximal humerus. Results: A first model generation was developed exemplified on the Multiloc humerus nail (Synthes GmbH) and validated with existing biomechanical test data. A workflow was developed for efficiently performing parametric analyses and meaningful data evaluation. First design questions have been investigated.

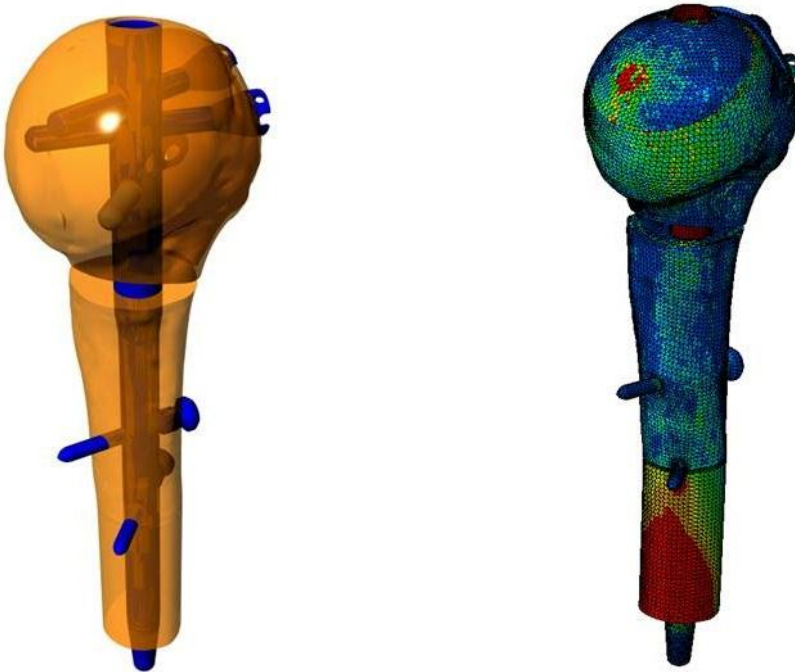

#### Partners:

- Südkamp N (UEEG), University Hospital Freiburg, Germany
- Resch H (UEEG), University Hospital Salzburg, Austria
- Nijs S (UEEG), UZ Leuven, Belgium
- Thomas G, Synthes GmbH, Solothurn, Switzerland

#### Biomechanical investigation of basic cerclage performance in view of application to periprosthetic fractures

Problem: Cerclage technology is regaining acceptance among surgeons due to the increasing number and demands of periprosthetic hip fractures. Combined with a splinting plate or shaft of prosthesis, cerclages are less loaded compared to a cerclage-only use. New instruments allow cerclage application through a minimally invasive approach. With the introduction of cables and crimps, cerclage performance, particularly in the locking procedure, has been optimized in recent years. Lasting and reliable cerclage tension which is essential to provide stability to the fracture site can now be created. This was not possible with former locking technologies. Goal: To investigate the mechanical performance of cable cerclages in comparison to conventional wire cerclages under cyclic loading with respect to clinical application. Results: Cerclage cables failed solely by rupture of the cable with no crimp loosening observed. Cerclage wires failed because of unraveling of the twist or wire breakage at the bottom twist. Differences between the four biomechanically tested groups comprising six specimens per group, instrumented with cerclage with  $\varnothing 1.0$  mm and  $\varnothing 1.7$  mm cables, and two  $\varnothing 1.0$  mm and  $\varnothing 1.5$  mm wires, were statistically significant for pretension, beginning of plastic deformation and load to total failure. Compared to wire cerclages, cable cerclages tolerated significantly higher load before plastic-construct deformation and total failure occurred, which seems to partially explain the poor outcome of former cerclage wiring. Cable cerclages with crimp closure generated a significantly higher pretension compared to wire cerclages.

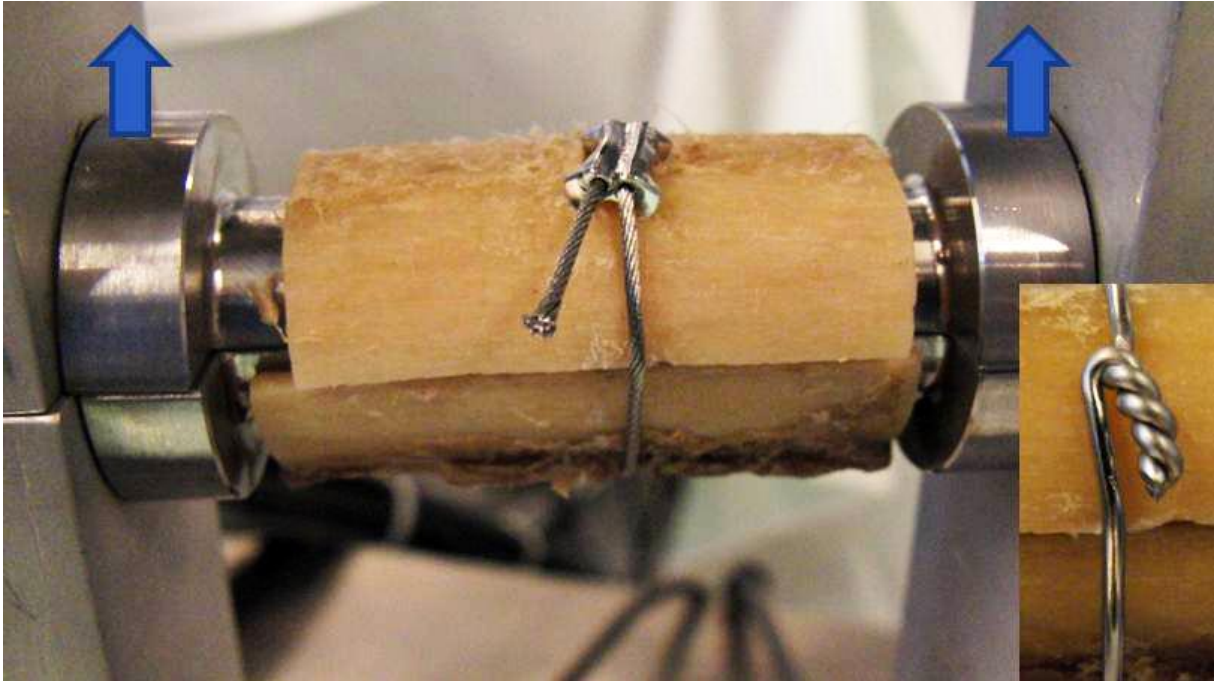

**Pub:**

Perren, S. M., Fernandez, A., Lenz, M., Windolf, M. Cerclage, Evolution and Potential of a Cinderella Technology. An Overview with Reference to Periprosthetic Fractures. *Acta Chirug. Orthop.* 2011 ;78: 190-9

Wähnert, D., Lenz, Schlegel, U., Perren, S. M., Windolf, M. Cerclage Handling for Improved Fracture Treatment. A Biomechanical Study on the Twisting Procedure. *Acta Chirug. Orthop.* 2011 ;78: 208-14

**Partners:**

- Dankward Höntzsch, MD PhD, BG Trauma Hospital Tübingen, Schnarrenbergstrasse 95, 72076 Tübingen, Germany

**Comparison of composite, porcine and human bones for biomechanical testing with focus on foot MTP fusion techniques**

Problem: Human bone is considered to be the best one for biomechanical studies, but its varying inter individual quality and mechanical properties have direct influence on the study results. Goal: To compare porcine and composite bone to old-aged human bone in order to evaluate their suitability for biomechanical studies with focus on foot surgery. Results: Bone mineral density was significantly lower in human bone compared to porcine bone. Composite bone exhibited higher axial construct stiffness and maximal pullout force for 3.5 mm conventional and 2.7 mm head-locking screw types compared to porcine and human bone. Differences between all biomechanically tested pairs of groups with the same instrumented screw type were significant for axial stiffness and ultimate pullout force. Head-locking and conventional screws exhibited significantly different maximal shear pullout force in human bone but not in porcine one.

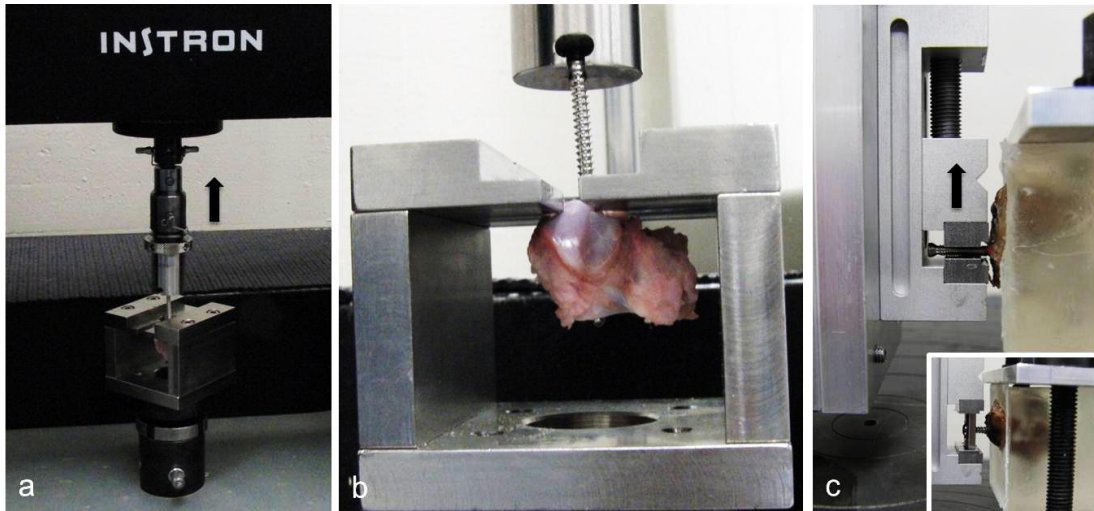

#### Partners:

- Andrew K. Sands, MD, New York Downtown Orthopedic Associates; 170 William Street, New York, NY 10038, USA
- Michael Castro, MD, Scottsdale Healthcare, Scottsdale, AZ, 85255, USA
- Ian Winson, MD, Southmead Hospital, Bristol, BS10 5NB, GB

#### Definition of a Workflow for Automated Assessment of Fracture Severity from Computed Tomography (AOTK Trauma LEEG)

The goal of a recently approved TK LEEG multicenter study is to identify the most important predictors of the functional outcome after pilon fractures, in particular as to whether the quality of the initial fracture reduction has to be considered to predict the final outcome and the risk for the development of osteoarthritis. Included in the study will be the analysis of objective fracture severity criteria using preoperative CT data. However, up to now there still remains an open question about suitable CT criteria representing fracture severity, and about their assessment on standard preoperative CT data.

Present TK project application aims to technically support the TK LEEG multicenter study by establishing the technical background for automated or nearly automated extraction of CT criteria showing high correlation to fracture severity. We propose to define a new workflow including (i) novel computerized image analysis tools, (ii) a CT training dataset of given clinical pilon fracture cases (retrospective data), that will be trained by clinical experts, and (iii) an Artificial Intelligence environment for automated analysis of large datasets and for correlating the different CT criteria to fracture severity. These newly developed tools will be then tested in additional CT data and, if successful, the workflow will be finally implemented into data analysis of the TK LEEG multicenter study.

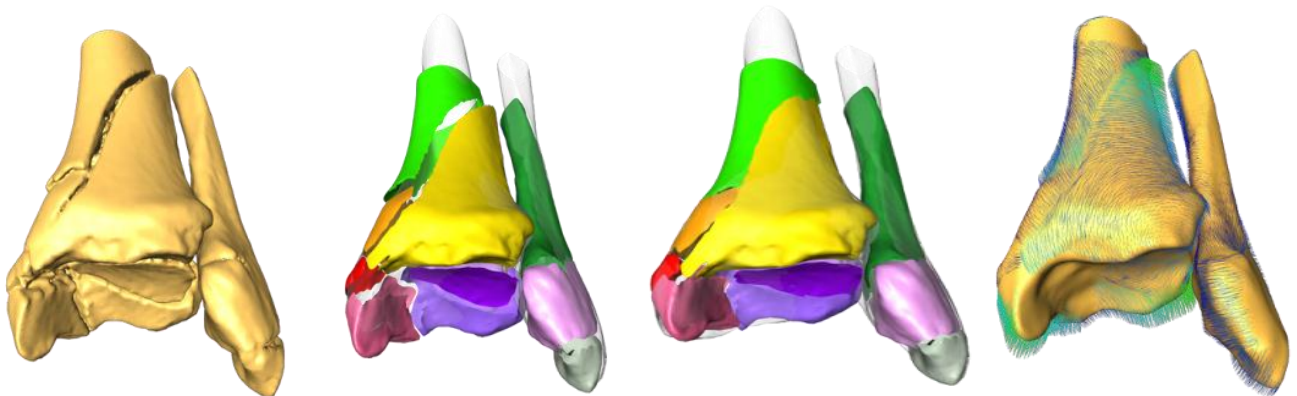

A software tool for virtual fracture reduction was developed to re-establish pre-injury anatomy and to estimate dislocation grade of fragments.



### Partners:

- Sean Nork, MD, Harborview Medical Center, Department of Orthopedic Surgery, Seattle, USA
- Christoph Sommer, MD Department of Surgery, Kantonsspital Graubünden, Chur, Switzerland
- Matt Graves, MD, University of Mississippi Medical Center Jackson, Mississippi, USA
- Sabine Goldhahn, MD, Consultant, AO Clinical Investigation and Documentation, Dübendorf, CH

### Preformed Cranial Implants (AOTK CMF NSEG)

Craniofacial defects are usually repaired using polymethylmethacrylate or flat titanium implants or autologous bone grafts. They are manually shaped according to the size and shape of the defect. Another option is to produce patient specific implants, however they require considerable preparation effort before surgery, furthermore they are costly. A new strategy is to develop anatomically preformed cranioplasty implants which could be adapted to the individual situation just with minor size and shape adaptations. It could constitute a time as well as cost efficient solution, while still achieving a satisfactory clinical outcome. The ARI Human Morphology Services will be involved in the project part I. There the goal is to establish a scientific anatomical background for the development of such implants using CT based three-dimensional statistical modeling and analysis techniques. The goal of the project is to design a preformed cranial shape implant for use in cranial reconstruction operations. The project team will define the required shape, size and implant location for the most common cranial defects. Different skull shapes based upon ethnicity and/or sex may be factored into the final result.

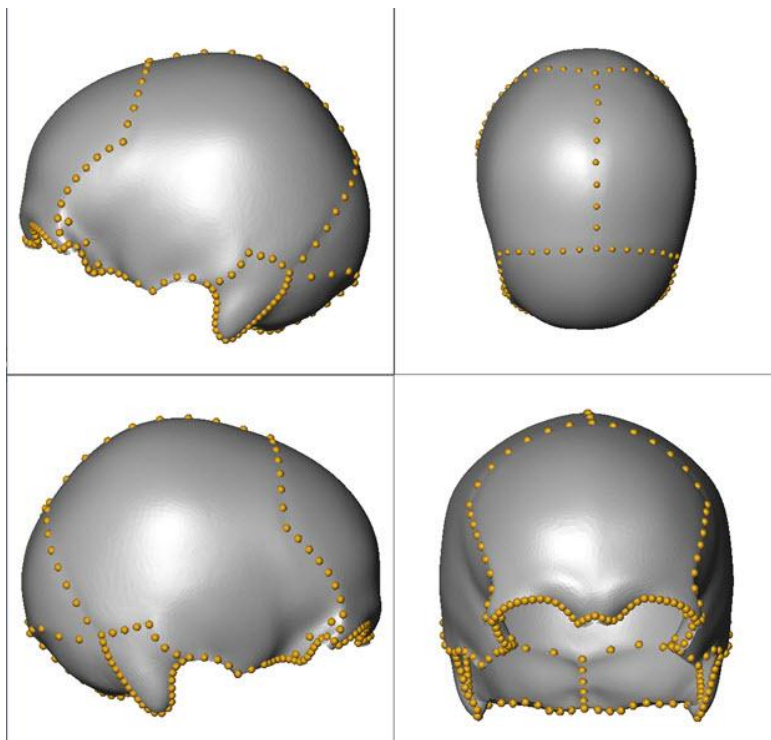

Definition of anatomical homological regions in a 3D reference model of the calvaria.

### Partners:

- Kurtis Wheeler, Synthes GmbH, Oberdorf, Switzerland
- Beat Hammer, Prof. Dr.med. Dr.med.dent., Cranio-Facial Center (cfc) Hirslanden, Aarau, Switzerland

## AO Exploratory Research

### Thermoresponsive hydrogels based on natural polysaccharide (Hydrohyal) (completed)

Designing functional, highly hydrated, 3D architectures at the cell scale has become the paradigm for triggering biological events via spatially and temporally controlled biological cues or drugs and the formation/regeneration of organized biological tissues. Among proposed solutions, injectable polymeric compositions capable of delivering tissue pieces, cells and drugs, and gelling *in situ* are one of the most promising. In fact, compared to large macro-porous polymeric scaffolds, injectable biodegradable polymeric compositions mimic more closely the hydrated 3D structure of the tissues extracellular matrix.

Traditional coupling method and new “click” chemistry approaches have been developed for the preparation of thermo-reversible hyaluronan compositions, designed to be flowing, deformable liquids at room temperature that form stable, physical gels when exposed to body temperature. The hydrogels mechanical properties, degradation and structure were modulated by modification of the synthetic polymer combined to the natural polymer (e.g. length, addition of a degradable segment, concentration), and the degree of grafting and cross-linking between the polysaccharide and the thermo-reversible polymer. Cells (e.g. chondrocytes, stem cells) were mixed in the material before the jellification, injected through a needle before gelling at body temperature. As no chemicals or noxious UV light were involved in the jellification, the hydrogels were none cytotoxic and the cells were viable in the gelled biodegradable materials. The thermo-reversible hyaluronan compositions provide an injectable 3D matrix platform that can be further functionalized with small molecules or proteins and tuned for use in regenerative therapies targeting bone and cartilage repairs, using stem cells and tissues pieces.

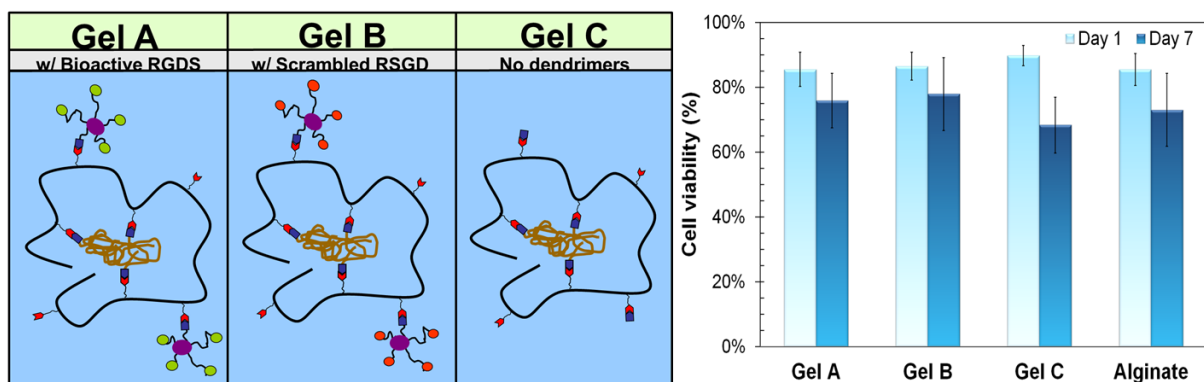

Schematic of three biofunctionalized thermoreversible hydrogels and encapsulated hMSCs viability after 1 and 7 days of culture as quantified by Live/Dead assay.

#### Pres:

Peroglio, M., Eglin, D., Grad, S., Alini, M., Long Beach (CA), USA (January 2011) “Assessment of nucleus pulposus cell phenotype cultured in thermoreversible hyaluronan-based hydrogels”

Peroglio, M., Eglin, D., Alini, M., Grad, S., Long Beach (CA), USA (January 2011) “Thermoreversible hyaluronan-based hydrogels for Cartilage Repair”

Seelbach R, Fransen P, Peroglio M, Royo M, Eglin D, Mata A, Alini M. Developing an injectable biofunctional, biomimetic hydrogel scaffold for regenerative medicine applications. 2011. TERMIS. Granada, Spain

Seelbach R, Peroglio M, Fransen P, Royo M, Mata A, Alini M, Eglin D. Designing a multifunctional, thermoreversible hyaluronan-based hydrogel scaffold for tissue regeneration. 2011. SSB. Yverdon-Les-Bains, Switzerland

#### Pub:

Peroglio M, Grad S, Mortisen D, Sprecher CM, Illien-Junger S, Alini M, Eglin D. Injectable thermoreversible hyaluronan-based hydrogels for nucleus pulposus cell encapsulation. Eur Spine J 2011; epub Aug 27

Gimeno-Fabra M., Peroglio-Martynovitch M., Eglin D., Alini M., Perry CC. (2011), Combined Controlled Release of Platelet-Rich Plasma and 3D-Cell Encapsulation in Alginate Hydrogels modified by the presence of Silica. J. Mater. Chem. 2011;21:4086-4089

**Partners:**

- Dr. Alvaro Mata, Parc Científic Barcelona, Spain

**Endothelialized grafts for bone critical size defect treatment (EPCgraft) (completed)**

Angiogenesis is a key factor in early stages of wound healing and is also crucial for tissue regeneration. In cases of large bone defect, to date most of the efforts have been focused on the filling of the gap with autologous bone grafts, or various bio-active materials associated or not with bone forming cells. However, vessels' ingrowth from nearby tissues and therefore implant neo-vascularization is insufficient in most large defect healing. The aim of this study was to develop an *in vitro* pre-vascularized implant for large bone defect, using 100% autologous biological components (cells, biological stimulation factors) combined with polyurethane scaffolds. During this project, we were able to demonstrate the beneficial effect of growth factors cocktail prepared from platelet lysates (PL release growth factors) on the growth and differentiation of Mesenchymal Stem Cells (MSC) and Endothelial Progenitor Cells (EPC, CD34+ and CD133+). We also showed that 3D co-culture of these 2 cell populations promotes each other's differentiation toward a functional osteoblastic- and endothelial phenotype respectively. We showed the *in vitro* formation of luminal tubular structures in the co-seeded scaffolds as early as day 7 in culture. These tubular structures were proven positive for both endothelial cell markers vWF and PECAM-1. Of special significance in our co-culture models is the presence of cells positive for CD146 (pericyte marker), as a part of neo-vasculature scaffolding. These CD146 positive cells coming from the mesenchymal stem cells population also expressed further markers of pericytes cells (NG2 and  $\alpha$ MA). Pericytes are known to have a pivotal function in the stabilization of the new formed pre-vascular network. The cell culture medium has proven to be as important as the combination of cells that are seeded in the scaffolds. The presence of angiogenic factors in association with osteogenic factors seems to be crucial for the two cell populations' cooperation. When implanted subcutaneously in the back of nude mice, the presence of capillary-like structures was clearly detected in cell co-seeding cases.

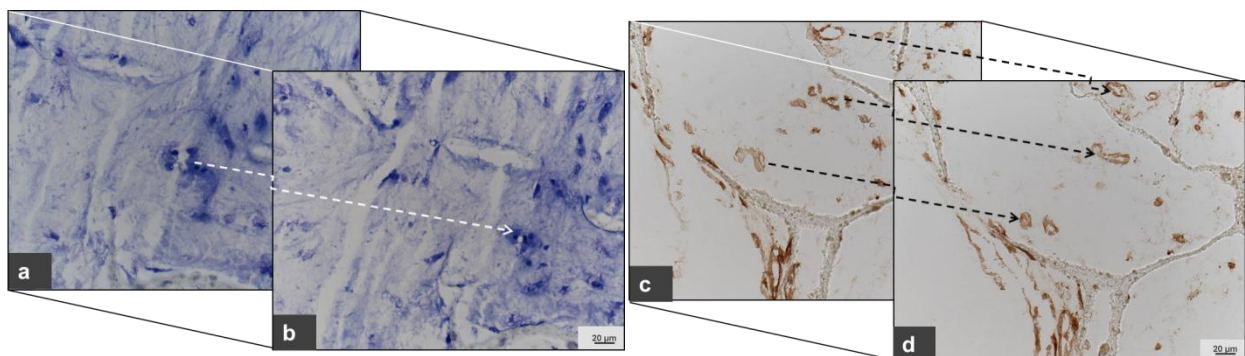

Sequential sectioning of scaffolds co-seeded with MSC and EPC. After 1 week incubation, cryosections (10 $\mu$ m) were performed and stained with basic toluidine blue staining (a, b) or using PECAM-1 specific antibody (c, d). The distance between 2 sections was around 100  $\mu$ m.

**Pres:**

Duttenhoefer F, Sauerbier S, Benneker L, Richards RG, Alini M, Verrier S. Pre-vascularization of 3D scaffolds for tissue engineering application in critical size bone defects. 2011. ADT

Duttenhoefer F, Lara de Freitas R, Loibl M, Richards RG, Alini M, Verrier S. *In vitro* prevascularisation of a 3D scaffold using autologous endothelial progenitor- and mesenchymal stem cells. J Miner Stoffwechs 2011;18 Suppl 2:24–5. SBMS 2011

Duttenhoefer F, Lara de Freitas R, Loibl M, Richards RG, Alini M, Verrier S. Endothelial Progenitor Cells (CD34+) and Bone Marrow Mesenchymal Stem Cells co-culture promotes 3D scaffold neovascularization. Histol Histopathol 2011; 26 Suppl 1. TERMIS 2011, Granada

Lara de Freitas R, Duttenhoefer F, Loibl M, Richards RG, Alini M, Verrier S. Osteogenic potential of total BMC (bone marrow mononucleated cells) versus EPC-depleted-BMC fraction (endothelial progenitor cells). J Miner Stoffwechs 2011;18 Suppl 2:25–6. SBMS 2011

Lara de Freitas R, Duttenhoefer F, Loibl M, Richards RG, Alini M, Verrier S. The EPC (Endothelial Progenitor Cells) fraction contained in the BMC (Bone marrow Monocyte Cell) population impairs the osteogenic differentiation. Histol Histopathol 2011; 26 Suppl 1. TERMIS 2011, Granada

**Pub:**

Lippross S, Loibl M, Hoppe S, Meury T, Benneker L, Alini M, Verrier S. Platelet released growth factors boost expansion of bone marrow derived CD34(+) and CD133(+) endothelial progenitor cells for autologous grafting. Platelets 2011; epub Apr 7

**Partner:**

- Dr M. Laschke Institute for Clinical & Experimental Surgery, University of Saarland, 66421 Homburg/Saar. DE

**Chondrogenesis of human bone marrow mesenchymal stem cells in fibrin-polyurethane composites (Stemload) (Ongoing)**

Tissue engineering is believed to be the future of articular cartilage repair due to the unsatisfying results of the current clinical procedures. Mesenchymal stem cells derived from bone marrow (BMSCs) have demonstrated the potential to differentiate into several cell lineages, including chondrocytes. Utilizing a multiaxial load bioreactor, we have been able to develop protocols that enable the induction of chondrogenesis using mechanical stimulation alone. This would suggest that mesenchymal stem cell therapies could be enhanced by using a suitable optimized rehabilitation protocol. To further enhance this process, we have been investigating gene therapy approaches. We have developed a low dose adenoviral transduction protocol which can be rapidly applied in 3D, using commonly used biomaterials such as fibrin gel. The dose of virus is very low, reducing any potential unwanted immunological response. The methods may also be adaptable if a more suitable gene transfer technology is developed. The process can easily be applied within the operating room and shows promise for future clinical translation.

**Pres:**

Li, Z, Yao, Alini, M, Stoddart, M J. The Role of Retinoic Acid Receptor Inhibitor LE135 on Osteochondral Differentiation of Human Bone Marrow Mesenchymal Stem Cells. TERMIS. 7th - 10th June, 2011, Grenada, Spain.

Neumann AJ, Alini. M, Stoddart MJ. Enhanced gene delivery using adenoviral vectors. Orthopedic Research Society Annual Meeting, 13 - 16 January 2011, Long Beach CA USA

Li, Z; Yao, S-J; Alini, M; Stoddart, M J. The Role of Retinoic Acid Receptor Inhibitor LE135 on Osteochondral Differentiation of Human Bone Marrow Mesenchymal Stem Cells. Swiss Stem Cell Network Meeting 4th. February 2011, Lausanne, Switzerland.

**Pub:**

L. Zhen, S.J. Yao, M. Alini, M.J. Stoddart. The Role of Retinoic Acid Receptor Inhibitor LE135 on the Osteochondral Differentiation of Human Bone Marrow Mesenchymal Stem Cells. J Cell Biochem. 2011 Mar;112(3):963-70. doi: 10.1002/jcb.23013 (IF: 3.122)

Sibylle Grad, David Eglin, Mauro R. Alini, Martin J. Stoddart. Physical stimulation of chondrogenic cells *in vitro*: A Review. Clinical Orthopaedics and Related Research. Clin Orthop Relat Res. 2011 (IF: 2.116)

**Partners:**

- Prof Charlie Archer, Cardiff Institute of Tissue Engineering and Repair, School of Biosciences, Cardiff University, Wales, United Kingdom
- Dr Gian Salzmann, Department of Orthopaedic and Trauma Surgery, University Medical Center, Albert-Ludwigs University Freiburg, Germany

**Isolation of functionally committed stem cells (Isostem) (Finished)**

The use of human mesenchymal stem cells as source material for cell based therapies for bone repair is hindered by the heterogeneous populations normally obtained. We aimed to develop a simple adenoviral based reporter system which would be responsive to active Runx2 transcription factor. Upon differentiation to osteoblasts the reporter is activated and cells express GFP allowing the responsive cells to be separated and harvested by fluorescent activated cell sorting (FACS). Using this system we have identified and isolated a population of cells which are highly osteogenic. Their alkaline phosphatase activity (a typical marker of osteogenic differentiation) is greatly increased and peaks at an earlier time point than negative or unsorted cells. This was confirmed at later time points where the incorporation of calcium is also enhanced in these cells. Using this system we also have indications that the different sub-populations signal to each other, affecting the behavior of the other sub-population. Currently available technologies could not isolate cells in this way and so this potential for cross-talk could not have been detected using any other method. This project will continue further in the newly approved Comstem project, where the cross-talk signaling will be investigated further and the technology platform will be expanded into new cell types such as endothelial cells.

**Pres:**

Bruderer M, Stoddart MJ, Alini M. Identification and isolation of committed osteogenic progenitors from a heterogeneous population of mesenchymal stem cells using a Runx2 reporter adenovirus. Orthopedic Research Society Annual Meeting, 13 - 16 January 2011, Long Beach CA USA

M. Bruderer, MJ. Stoddart, M. Alini. Characterization of osteoprogenitors functionally isolated from human mesenchymal stem cells by a RUNX2 reporter adenovirus. 17th Annual SBMS Meeting, 7th April, 2011, Inselspital, Bern

Bruderer, M; Stoddart, M J; Alini. M Functional identification and isolation of osteoprogenitors from human mesenchymal stem cells using a Runx2 reporter adenovirus. Swiss Stem Cell Network Meeting 4th. February 2011, Lausanne, Switzerland.

**Partner:**

- Prof Viola Vogel, Department of Materials Science, ETH Zurich, Switzerland

**Investigation of bone marrow stem cells in the bone marrow niche in an *in vitro* system (Stemcart) (Ongoing)**

Within this project, we aim to develop an *in vitro* culture system to mimic the human bone marrow stem cell niche in an artificial perfusion bioreactor environment, in order to culture human adult stem cells. With this new bioreactor system we aim to keep the viable human bone marrow stem cells in a quiescent state, as they are within the human long bone niche. The system will allow for controlled fluid flow and its multi-chamber design allows for various media compositions to be compared. It is known that stem cell behavior is strongly affected by the stiffness of the supporting substrate. Therefore, we have been optimizing the cell scaffold carrier system in order to provide the cells with microenvironment which is suitable at the mechanical level. They will then be cultured using a fluid flow rate which is able to maintain viability while not providing any differentiation stimulus. We aim to use this system to investigate the behavior of freshly isolated cells. This is crucial as it is freshly isolated cells, not monolayer

expanded mesenchymal stem cells, which are available to surgeons and could be applied within a single surgical procedure intraoperatively. Knowledge of the mesenchymal stem cell niche will greatly improve the methodologies used later in future bone marrow stem cell research and clinical application.

**Pres:**

P. Lezuo, M.Stoddart, M.Alini. Microfluidic CFD simulation for stem cell bioreactor system. German SIMULIA-Congress 2011 Bamberg, September, 20th 2011

**Nucleus pulposus and annulus fibrosus cells: Cellular phenotype characterization and *in vitro* differentiation from mesenchymal stem cells (Discphen) (Ongoing)**

One reason for axial back pain is the degeneration of the extracellular matrix within the intervertebral disc. An attractive approach is to specifically target intervertebral disc cells for anabolic or anti-catabolic treatment. However, there is still not sufficient knowledge about the molecular characteristics of the intervertebral disc cells, namely nucleus pulposus (NP) and annulus fibrosus (AF) cells. In particular, there is a lack of specific markers that define the disc cell phenotype. We have set out to associate NP cells with cell surface-specific proteins different from closely related cell types, namely intervertebral disc AF cells and articular cartilage (AC) chondrocytes, in order to derive surface molecules as specific markers and for directed delivery of therapeutic agents. A cDNA microarray was carried out on 16 human samples from 6 patients followed by a systematic approach for gene list reduction. Genes that were more highly expressed in NP than AC cells, contained transmembrane domains and appeared attractive for targeting were assessed by quantitative real-time RT-PCR. As a viable candidate, carbonic anhydrase 12 (CA12) was analyzed at the protein level using immunohistochemistry and a functional study. Microarray results demonstrated a clear divide between the AC and AF and between the AC and NP samples. However, the transcriptomic profile of AF and NP samples displayed a greater inter-patient similarity over cell type. Of the 552 genes with up-regulated expression in NP cells, 90 contained transmembrane domains, and 28 were quantified by RT-PCR. Most intense CA12 labeling was observed in the NP of young discs and in degenerative tissue. Our findings suggest that CA12 may be involved in the pH regulation of NP cells. CA12 may be considered not only as an NP marker molecule but also for detection or targeting of degenerating disc cells. Its potential for directed delivery of regenerative factors and its functional role in NP cell homeostasis necessitate further investigation.

**Pres.:**

Grad S, Rutges J, Cremers LB, Buttner A, Milz S, Alini M. Differential Gene Expression of Human Nucleus Pulposus Cells and Articular Chondrocytes: What Defines the Intervertebral Disc Cell Phenotype? ORS 2011, Long Beach, USA.

Stoyanov JV, Gantenbein-Ritter B, Aebli N, Baur M, Alini M, Grad S. Role of Hypoxia, GDF5 and TGF-beta on Differentiation of Human Mesenchymal Stem Cells Towards Intervertebral Nucleus Pulposus-Like Cells. ORS 2011, Long Beach, USA.

Stoyanov J, Gantenbein-Ritter B, Alini M, Grad S. Differentiation of mesenchymal stem cells: Evaluation of different stimuli and of new markers to distinguish chondrogenic from intervertebral disc-like differentiation. 2011. GSC Barcelona, Spain.

**Pub.:**

Gantenbein-Ritter B, Benneker LM, Alini M, Grad S. Differential response of human bone marrow stromal cells to either TGF-beta1 or rhGDF-5. *Eur Spine J.* 20(6):962-71, 2011.

Stoyanov JV, Gantenbein-Ritter B, Bertolo A, Aebli N, Baur M, Alini M, Grad S. Role of hypoxia and growth and differentiation factor-5 on differentiation of human mesenchymal stem cells towards intervertebral disc nucleus pulposus-like cells. *Eur Cell Mater* 21:533-47, 2011.

Power K, Grad S, Rutges J, Creemers LB, Van Rijen M, O Gaora P, Wall G, Alini M, Pandit A, Gallagher W. Identification of cell surface markers to target human nucleus pulposus cells: expression of carbonic anhydrase XII varies with age and degeneration. *Arthritis Rheum* 63(12):3876-86, 2011.

## Partners:

- Prof. A. Pandit, National University of Ireland, Galway; Prof. W. Gallagher, University College Dublin, Ireland;
- Dr. J. Rutgers, University Medical Center Utrecht, The Netherlands
- Dr. L.B. Creemers, University Medical Center Utrecht, The Netherlands
- Prof. W. Dhert, University Medical Center Utrecht, The Netherlands

## Extramural funded project abstracts

### Gene Activated Matrices for Bone and Cartilage Regeneration in Arthritis (GAMBA) (ongoing)

This consortium develops a novel gene-activated matrix platform for bone and cartilage repair with a focus on osteoarthritis-related tissue damage. The S&T objectives of this project are complemented with an innovative program of public outreach, actively linking patients and society to the evolvement of this project. The GAMBA platform is implementing a concept of spatiotemporal control of regenerative bioactivity on command and demand. A gene-activated matrix is a biomaterial with embedded gene vectors that will genetically modify cells embedded in the matrix. The platform comprises modules that self-adapt to the biological environment and that can be independently addressed with endogenous biological and exogenous physical or pharmacological stimuli, resulting in a temporally and spatially coordinated growth factor gene expression pattern. This reproduces, within the matrix, key elements of natural tissue formation. The modules are a biomimetic hyaluronan gel being developed at the AO Research Institute Davos, a ceramic matrix, growth factor-encoding gene vector nanoparticles, magnetic nanoparticles and mesenchymal stem cells. Anatomical adaptivity is achieved with engineered thermal properties of the polymer matrix, which embeds other modules, selected according to functional requirements. Mechanical support is provided by Micro Macroporous Biphasic Calcium Phosphate (MBCP™), a resorbable material approved for clinical use. Spatiotemporal control of bioactivity and responsiveness to physiological conditions is represented, firstly, in the spatial distribution and release profiles of gene vectors within the composite matrix and, secondly, by letting local and external biological or physical stimuli activate the promoters driving the expression of vector-encoded transgenes. The research receives funding from the European Union's 7th Framework Program under grant agreement n° NMP3-SL-2010-24.

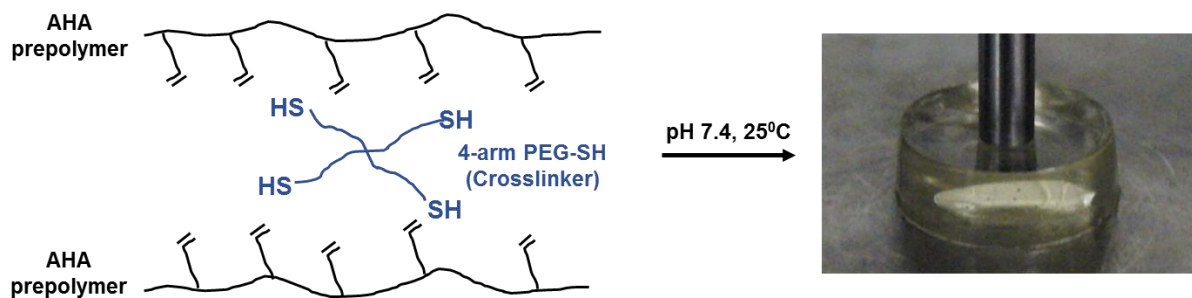

Images of N-acrylate hyaluronic acid gel using 4-arm thiol-poly(ethylene glycol) crosslinker at room temperature.

## Pres:

Sukarto A, Sapet C, Alini M, Eglin D. Nucleic acids tranfection in thermoreversible hyaluronan-based gel. Swiss Society for Biomaterials Conference, Yverdon-Les-Bains, 2011.

## Partners:

- 10 European partners

### **Biomimetic nano-fiber-based nucleus pulposus regeneration for the treatment of degenerative disc disease (NPMimetic) (ongoing)**

The intervertebral discs form the elastic part of the spine. It is composed of the annulus fibrosus, a tough outer layer of fibrocartilage, surrounding an elastic gelatinous core, the nucleus pulposus (NP). With age, the water content of the NP decreases, thus, the mechanical loads concentrate on the annulus. This leads to the NP wear, and cracking with a subsequent inflammation reaction and a prolapsed intervertebral disc. The process forms a cycle of accelerated pathology of degenerative disc disease. The "Gold Standard" for treatment is the "spinal fusion", an extensive surgery, which blocks definitively free spine motion. Surgeons seek new technologies to allow motion preservation, with long-term outcomes. Based on electrospinning proprietary technology of partner NICAST and a novel chemically modified extracellular matrix-based biopolymer, developed by partner ProCore, the NPMimetic consortium will develop biomimetic nano-polymer based gel for minimally invasive treatment for disc regeneration: Electrospinning technology will be exploited to design and develop a nano-fiber based, biocompatible, biodegradable, synthetic scaffold that will mimic mechanical properties of native NP for immediate and short term treatment. Anabolic and/or anti-inflammatory drugs will be carried by biodegradable nano-fibers to be gradually released *in situ* thus, healing and/or preventing inflammation. Furthermore, the synthetic scaffold will be integrated with the bioactive-polymer that is highly potent in supporting NP cells for long-term cure. A multidisciplinary study will answer scientific and engineering questions raised by the NPMimetic approach, e.g. hydrogel swelling characteristics, drug delivery, and NP cells reaction to the biomimetic gel environment. All will be supervised by a strong leader in spine surgery to define inputs and outputs of the research, from a clinical implementation point of view. The research receives funding from the European Union's 7th Framework Program NMP-2009-2.3-1.

#### **Partners:**

- 10 European partners

### **Evaluation of antimicrobial peptide OP145 delivered via PolyPid coating as a prophylaxis and treatment of intramedullary nail related infection (BALI)**

Orthopedic implant related infections are prototypical biofilm infections with particularly high re-infection rates after secondary revision procedures due to the difficulty in eliminating the biofilm that is present on and surrounding the implant by conventional antibiotic therapy. This study aims to test antibiotic loaded coatings on an implant to combat orthopedic infections. The coatings based on two novel entities: a novel antimicrobial agent and a novel coating system. These coated implants will serve both prophylaxis of implant related infection and treatment of infected bones. This project is in the preparation phase in 2011, with experimental work to begin in 2012.

#### **Partners:**

- S.A.J. Zaat Amsterdam Medical Center, Netherlands,
- Noam Emanuel, Polypid Ltd. Israel



## 10. Operations Standards and Safety

### Successful 2011 routine audit of AO Research Institute

From April 14 to 15, 2011, two external auditors from the SQS (Swiss Association for Quality and Management Systems; [www.sqs.ch](http://www.sqs.ch)) visited ARI for the routine audit of the institute.



ARI keeps the existing certification for another two years without any non-conformities requiring immediate actions. Having held several open discussions with several staff members and management, the auditors were impressed by the levels of commitment and knowledge at both locations.

The entire AO Research Institute is certified according to the international standard ISO 9001:2008.

The Biomedical Services Program is additionally certified as a medical device manufacturer according to ISO 13485:2003.

ARI is one of the very few academic research organizations to have achieved this certification.

#### QM recommendations

The SQS certification auditor/assessors of ARI specifically mentioned that the new review system from the AO Foundation should NOT be applied to concept development or innovation projects, since this might cause major setbacks to such sensitive projects. This issue is part of the Research Review Process and will be decided by AOVA subsequently.

## 11. Team Members

### Director:

Richards R. Geoff                      Prof, Prof, PhD, MSc                      01.10.91

### ARI Management:

Alini Mauro                      Prof, PhD                      01.07.99  
 Bentz Ulrich                      Dipl Ing HTL Mikrotechnik                      01.08.07  
 Bouré Loudovic                      Prof, Dr med vet, MSc, DES, Diplomate ACVS                      18.09.06 – 31.03.11  
 Gueorguiev Boyko                      PhD, MSc                      (01.03.03 – 30.09.09)                      01.07.10  
 Keller Rolf                      Technischer Kaufmann                      17.06.96  
 Matthys Romano                      Medicine Technician TS/ Toolmaker                      01.08.94 – 31.12.11  
 Moriarty Fintan                      PhD, BSc                      19.03.07  
 Nehrbass Dirk                      Dr med vet, FTA Pathol + Toxicopathol                      01.10.10  
 Wahl Sonia                      Dipl DH Ökonomin HFP                      01.12.95  
 Wilke Markus                      Dr med vet, Dipl ACVS/ECVS                      22.08.11

### AO Senior Scientific Advisor:

Perren Stephan M.                      Prof, Dr med Dr sci (hc), Chirurg FMH                      01.01.64

### Scientific & Technical Staff:

Abegglen Nadine                      Administrative Assistant (50%)                      01.09.09  
 Agarwal Yash                      MEng, PhD Candidate                      07.10.10  
 Arens Daniel                      Dr med vet (01.06.03 – 30.09.06)                      01.11.07  
 Barblan Claudia                      Administrative Assistant (70%)                      15.11.10  
 Berri Fabian                      CNC Mechanics (60%) (01.08.99 – 31.07.03)                      01.11.07  
 Bluvol Mauro                      Chemielaborant (Eidg FA<sup>1</sup>)                      01.06.03  
 Bruderer Marco                      PhD Cand                      01.10.08  
 Camenisch Karin                      Technical Assistant (40%)                      07.04.08  
 Caspar Jan                      Poly mechanics                      01.01.09  
 Czekanska Ewa                      PhD Cand, MPhil, Msc                      07.10.08  
 D'Este Matteo                      PhD                      01.04.11  
 Dicht Benno                      Mechaniker (Eidg FA<sup>1</sup>)                      01.01.78  
 Dresing Iska                      Med vet                      01.05.11  
 Egli Sandrine                      FH Biotechnologin, BSc                      14.02.11  
 Eglin David                      PhD                      01.06.06  
 Erb Peer                      Animal Care (Eidg FA<sup>1</sup>)                      03.05.93  
 Erdhöhely Balazs                      Computer Science and informatics                      01.08.11  
 Escher Carla                      Administrative Assistant (40%)                      01.01.95  
 Faoro Pierina                      Artzgehilfin (MPA)                      01.12.07  
 Fliri Ladina                      MsC ETH                      01.10.09  
 Forte Matthias                      Dipl Ing                      15.07.11  
 Furlong-Jäggi Pamela                      Chemikerin FH, BSc                      01.02.04  
 Furter Andrea                      Animal Care (Eidg FA<sup>1</sup>)                      24.04.06  
 Gardner Oliver                      PhD Cand                      27.10.11  
 Glarner Markus                      Chem Messtechniker (Eidg FA<sup>1</sup>)                      01.11.97  
 Goudsouzian Nora                      BSc                      01.02.02  
 Grad Sibylle                      Dr sc nat                      03.08.00  
 Heldstab Thomas                      Zeichner / Konstrukteur                      04.02.91  
 Kamer Lukas                      Dr med, Dr med dent (80%)                      21.05.07  
 Keller-Stoddart Iris                      MTL Technician                      21.10.09

<sup>1</sup> Eidg FA = Eidg Fähigkeitsausweis

Lanker Urban	Animal Care (Eidg FA <sup>1</sup> )	16.06.86
Lezuo Patrick	Dipl Eng / PhD Cand	01.08.03
Li Zhen	PhD	01.08.11
Menzel Ursula	PhD, Dipl Biol	01.07.11
Müller Gregor	Lic phil, Librarian (50%)	17.01.05
Müller Reto	Animal Care (Eidg FA <sup>1</sup> ) (80%)	13.11.01
Nehrbass Angela	Dr med vet (60%)	08.11.10
Neumann Alexander	PhD Cand, Dipl Biol	01.05.09
Noser Hansrudi	PD Dr ès science EPFL	18.10.04
Pattappa Gishish	PhD	01.07.10
Peroglio Marianna	PhD	01.03.09
Perren Dominic	Animal Care	01.02.83
Peter Robert	Dipl Laborant HFP	15.09.84
Post Virginia	PhD	20.09.10
Potapova Inga	PhD	01.01.10
Poulsso Alexandra	PhD, MSc, BEng	29.08.06
Rochford Edward	PhD Cand, MPhil, BSc	03.08.08
Schneider Monika	Administrative Assistant (50%)	06.02.06
Schraner Daniela	Administrative Assistant (50%)	15.04.10
Schwyn Ronald	Dipl Medizintechniker HF	01.11.92
Sharma Sonam	MSc, Biomedical Engineering	15.07.11
Sprecher Christoph	Dipl Ing FH	01.02.00
Stadelmann Vincent	PhD, Bioengineering EPFL	24.01.11
Stoddart Martin	PhD, MPhil, BSc	01.07.05
Sukarto Abby	MSc	13.10.10
Verrier Sophie	D res Science	01.08.04
Vivalda Marisa	Administrative Assistant	01.05.03
Wahl Dieter	Dipl techn Werkzeugspezialist HFP	01.11.93
Windolf Markus	Dip Ing TU	01.11.04
Zderic Ivan	MSc ETH	01.02.11
Zeiter Stephan	Dr med vet, PhD	01.06.03
Zweifel Erich	European Industrial Engineer EIE	30.11.92

### Apprentice

Adank Nando	Apprentice	01.08.11
Frey Kevin	Apprentice	01.08.11
Semadeni Gian Mario	Apprentice	01.08.11
Trüssel Patrick	Apprentice	01.08.09
Wyss Noel	Apprentice	01.08.08

### Internship

Ernst Manuela	Master Student	01.10.11
---------------	----------------	----------

### Medical Research Fellows:

Al-Saadi Hayder	Dr med	14.10.11
Shiozaki Yasuyuki	Dr med	15.08.11
Schmidutz Florian	Dr med	01.05.11
Seyboth Claus	Dr med	01.08.11

## Employees left 2011

### Scientific & Technical Staff:

Ambühl Ruedi	Mechaniker (Eidg FA <sup>1</sup> )	03.12.90 – 31.05.11
Däscher Peter	Maschinen Mechaniker (Eidg FA <sup>1</sup> )	01.10.89 – 31.12.11
Hintermann Tanja	Administrative Assistant	17.10.10 – 19.05.11
Nützi Reto	Production Technician TS / Design Engineer	01.08.07 – 31.12.11
Oswald Andrea D.	Apprentice	06.08.07 – 28.02.11
Rothstock Stephan	Dipl Ing	01.01.10 – 31.06.11
Schiama Damiano	Dr Eng	01.04.09 – 30.11.11
Schlegel Urs	PhD, Dipl Med Ing, Dip El Ing	17.10.88 – 31.12.11

### Internship

Eberli Ursula	Master Student	01.02.11 – 31.12.11
Schätti Oliver	BSc HMS	01.08.10 – 30.04.11
Viehöfer Ulf		01.07.11 – 30.09.11
Wismer Nadine	Master Student	01.03.11 – 31.12.11
Wolf Dominik	Internship	01.09.10 – 31.08.11

### Medical Research Fellows:

Alajmo Giuseppe	Dr med	30.06.10 – 31.01.11
Beck Aswin	Dr med vet	12.07.10 – 10.07.11
Calabro Lorenzo	Dr med	01.02.11 – 12.08.11
Duttenhöfer Fabian	Med	01.03.10 – 11.03.11
Gahukamble Abbhay	Dr med	11.07.11 – 20.12.11
Lara de Freitas Rafael	Dr med	04.02.10 – 31.01.11
Lenz Mark	Dr med	01.09.10 – 31.12.11
Popp Albrecht	Dr med	01.04.10 – 15.04.11
Salvarrieta Julian	Dr med	20.06.11 – 19.12.11
Valchev Desislav	Dr med	01.05.11 – 31.12.11
Varga Endre	DMD	01.03.10 – 28.02.11
Wissing Sandra	Dr med vet	01.05.11 – 31.12.11

### Non Medical Research Fellows:

Bago Balazs	Computer Science and informatics	01.04.11 – 31.12.11
Erdhöhely Balazs	Computer Science and informatics	01.08.10 – 31.01.11
Lutton Cameron	PhD	01.07.10 – 31.01.11

## Guests:

Bahney Chelsea	Orthopaedic Trauma Institute, San Francisco, USA, 28.-29.03.2011
Erggelet Julian	Medical Guest Research Fellow, Germany, 06.03.11 – 27.09.11
Erggelet Christoph	MD PhD, Switzerland, Musculoskeletal Regeneration
Larroze David	04.07. – 31.07.2011, Musculoskeletal Regeneration
Reuber Tobias	Albert-Ludwigs-Universität Freiburg, Germany, Project Cell Homing 05.09.11 – 31.03.12
Staudacher Judith	Albert-Ludwigs-Universität Freiburg, Germany, Project Chondrogenese 05.09.11 – 31.03.12
Masumeci Giuseppe,	PhD, Assistant Professor of Human Anatomy, Dep of Bio-Medical Sciences, University of Catania, Italy, 05.09.11 – 24.02.12
Miclau Ted	Prof, Orthopaedic Trauma Institute, San Francisco, USA, 28.-29.03.2011
Russo Frederico	Guest MD, Musculoskeletal Regeneration
Seelbach Ryan	MSc, University of Barcelona, Spain, 22.03.10 – 28.02.2011
Sermon An	MD, UZ Leuven, Traumatology, Leuven, Belgium, 1.5. – 30.06.2011 Biomedical Services
Turalija Marina	PhD Student, EMPA Swiss Federal Laboratories for Materials science and technology, St Gallen, Switzerland, 06.06. - 06.07.11, Musculoskeletal Infection
Vadulà Gian-Luca	Guest MD, Musculoskeletal Regeneration
ICRS Fellowship visit:	30.08.2011
Patrick McCulloch, MD,	USA Takehiko Matsushita, MD, PhD, Japan Marco Demange, MD, Brasil Lars Peterson, MD, Sweden

## 12. Publications & Presentations

### Peer reviewed publications

- Arens D, Rothstock S, Windolf M, Boger A.  
Bone marrow modified acrylic bone cement for augmentation of osteoporotic cancellous bone.  
J Mech Behav Biomed Mater 2011; 4:2081-2089 (IF 3.297)
- Borumandi F, Hammer B, Kamer L, von Arx G.  
How predictable is exophthalmos reduction in Graves' orbitopathy? A review of the literature.  
Br J Ophthalmol 2011;95:1625-1630 (IF 2.934)
- Braunstein V, Duda S, Sprecher CM, Brighenti V, Arora R, Tami A, Lutz M, Milz S. [Comparison of regional distribution of cancellous bone in osteoporotic and non-osteoporotic distal radii].  
Unfallchirurg 2011;114:424-430 (IF 0.675)
- Brianza S, Roderer G, Schiuma D, Schwyn R, Scola A, Gebhard F, Tami AE.  
Where do locking screws purchase in the humeral head?  
Injury 2011; epub Nov 14 (IF 2.269)
- Collin EC, Grad S, Zeugolis DI, Vinatier CS, Clouet JR, Guicheux JJ, Weiss P, Alini M, Pandit AS.  
An injectable vehicle for nucleus pulposus cell-based therapy.  
Biomaterials 2011;32:2862-70 (IF 7.882)
- Egermann M, Gerhardt C, Barth A, Maestroni GJ, Schneider E, Alini M.  
Pinelectomy affects bone mineral density and structure - an experimental study in sheep.  
BMC Musculoskelet Disord 2011;12:271 (IF 1.940)
- Gahlert M, Roehling S, Sprecher CM, Kniha H, Milz S, Bormann K.  
*In vivo* performance of zirconia and titanium implants: a histomorphometric study in mini pig maxillae.  
Clin Oral Implants Res 2011; epub Aug 02 (IF 2.812)
- Gantenbein-Ritter B, Benneker LM, Alini M, Grad S.  
Differential Response of Human Bone Marrow Stromal Cells to either TGF-beta1 or rhGDF-5.  
Eur Spine J 2011;20:962-71 (IF 1.994)
- Grad S, Eglin D, Alini M, Stoddart MJ.  
Physical Stimulation of Chondrogenic Cells *In vitro*: A Review.  
Clin Orthop Relat Res 2011;469:2764-2772 (IF 2.116)
- Gueorguiev B, Wähnert D, Albrecht D, Ockert B, Windolf M, Schwieger K.  
Effect on dynamic mechanical stability and interfragmentary movement of angle-stable locking of intramedullary nails in unstable distal tibia fractures: a biomechanical study.  
J Trauma 2011;70:358-65 (IF 3.129)
- Gueorguiev B, Ockert B, Schwieger K, Wähnert D, Lawson-Smith M, Windolf M, Stoffel K.  
Angular stability potentially permits fewer locking screws compared with conventional locking in intramedullary nailed distal tibia fractures: a biomechanical study.  
J Orthop Trauma 2011;25:340-6 (IF 1.792)
- Hahn J, Witte TS, Arens D, Pearce A, Pearce S.  
Double-plating of ovine critical sized defects of the tibia: A low morbidity model enabling continuous *in vivo* monitoring of bone healing.  
BMC Musculoskelet Disord 2011;12:214 (IF 1.940)
- Harvey EJ, Giannoudis PV, Martineau PA, Lansdowne JL, Dimitriou R, Moriarty TF, Richards RG.  
Preclinical animal models in trauma research.  
J Orthop Trauma 2011;25:488-93 (IF 1.792)

Horn J, Gueorguiev B, Brianza S, Steen H, Schwieger K.  
Biomechanical evaluation of two-part surgical neck fractures of the humerus fixed by an angular stable locked intramedullary nail.  
J Orthop Trauma 2011;25:406-13 (IF 1.792)

Iatridis JC, Godburn K, Wuertz K, Alini M, Roughley PJ.  
Region-dependent aggrecan degradation patterns in the rat intervertebral disc are affected by mechanical loading *in vivo*.  
Spine (Phila Pa 1976 ) 2011;36:203-9 (IF 2.510)

Krause FG, Windolf M, Bora B, Penner MJ, Wing KJ, Younger AS.  
Impact of Complications in Total Ankle Replacement and Ankle Arthrodesis Analyzed with a Validated Outcome Measurement.  
J Bone Joint Surg Am 2011; 93:830-839 (IF 2.967)

Kubosch D, Milz S, Lohrmann C, Schwieger K, Konstantinidis L, Sprecher CM, Sudkamp NP, Strohm PC.  
Risk of graft fracture after dorso-ventral thoraco-lumbar spondylodesis: is there a correlation with graft size?  
Eur Spine J 2011;20:1644-1649 (IF 1.994)

Laschke MW, Mussawy H, Schuler S, Kazakov A, Rucker M, Eglin D, Alini M, Menger MD.  
Short-term cultivation of *in situ* prevascularized tissue constructs accelerates inosculation of their preformed microvascular networks after implantation into the host tissue.  
Tissue Eng Part A 2011;17:841-53 (IF 4.636)

Li Z, Yao SJ, Alini M, Stoddart MJ.  
The role of retinoic acid receptor inhibitor LE135 on the osteochondral differentiation of human bone marrow mesenchymal stem cells.  
J Cell Biochem 2011;112:963-70 (IF 3.122)

Lippross S, Loibl M, Hoppe S, Meury T, Benneker L, Alini M, Verrier S.  
Platelet released growth factors boost expansion of bone marrow derived CD34(+) and CD133(+) endothelial progenitor cells for autologous grafting.  
Platelets 2011; epub Apr 7 (IF 2.117)

Mendel T, Hanni M, Gueorguiev B, Wohlrab D, Hofmann GO.  
The virtual isocentric aiming device: a new mechanical targeting concept.  
Arch Orthop Trauma Surg 2011;131:1655-1662 (IF 1.196)

Mendel T, Noser H, Wohlrab D, Stock K, Radetzki F.  
The lateral sacral triangle - a decision support for secure transverse sacroiliac screw insertion.  
Injury 2011;42:1164-70 (IF 2.269)

Noser H, Radetzki F, Stock K, Mendel T.  
A method for computing general sacroiliac screw corridors based on CT scans of the pelvis.  
J Digit Imaging 2011;24:665-71 (IF 1.421)

Ockert B, Braunstein V, Sprecher CM, Shinohara Y, Milz S.  
Fibrocartilage in various regions of the human glenoid labrum. An immunohistochemical study on human cadavers.  
Knee Surg Sports Traumatol Arthrosc 2011; epub Oct 05 (IF 1.857)

Peroglio M, Grad S, Mortisen D, Sprecher CM, Illien-Junger S, Alini M, Eglin D.  
Injectable thermoreversible hyaluronan-based hydrogels for nucleus pulposus cell encapsulation.  
Eur Spine J 2011; epub Aug 27 (IF 1.994)

Perren SM, Fernandez DA, Lenz M, Windolf M.  
Cerclage, Evolution and Potential of a Cinderella Technology. An Overview with Reference to Periprosthetic Fractures.  
Acta Chir Orthop Traumatol Cech 2011;78:190-9 (IF 1.620)

Popp AW, Windolf M, Senn C, Tami A, Richards RG, Brianza S, Schiuma D.  
Prediction of bone strength at the distal tibia by HR-pQCT and DXA.  
*Bone* 2011;50:296-300 (IF 4.601)

Power KA, Grad S, Rutges JP, Creemers LB, van Rijen MH, O'Gaora P, Wall JG, Alini M, Pandit A, Gallagher WM.  
Identification of cell surface-specific markers to target human nucleus pulposus cells: Expression of carbonic anhydrase XII varies with age and degeneration.  
*Arthritis Rheum* 2011;63:3876-86 (IF 8.435)

Rathnayaka K, Momot KI, Noser H, Volp A, Schuetz MA, Sahama T, Schmutz B  
Quantification of the accuracy of MRI generated 3D models of long bones compared to CT generated 3D models.  
*Med Eng Phys* 2011; epub Aug 18 (IF 1.906)

Rausch S, Klos K, Stephan H, Hoffmeier K, Gras F, Windolf M, Gueorguiev B, Hofmann GO, Muckley T.  
Evaluation of a polyaxial angle-stable volar plate in a distal radius C-fracture model - A biomechanical study.  
*Injury* 2011;42:1248-1252 (IF 2.269)

Rausch S, Hoffmeier K, Gueorguiev BG, Klos K, Gras F, Hofmann GO, Mückley T.  
[Comparative Study on the Strength of Different Mechanisms of Operation of Multidirectionally Angle-Stable Distal Radius Plates.]  
*Z Orthop Unfall* 2011;149:694-698 (IF 0.343)

Sadri H, Stern R, Singh M, Linke B, Hoffmeyer P, Schwieger K.  
Transverse fractures of the olecranon: a biomechanical comparison of three fixation techniques.  
*Arch Orthop Trauma Surg* 2011;131:131-8 (IF 1.196)

Salzmann GM, Buchberger MS, Stoddart MJ, Grad S, Milz S, Niemyer P, Sudkamp N, Imhoff AB, Alini M.  
Varying regional topology within knee articular chondrocytes under simulated *in vivo* conditions.  
*Tissue Eng Part A* 2011;17:451-61 (IF 4.636)

Schätti O, Grad S, Goldhahn J, Salzmann G, Li Z, Alini M, Stoddart MJ.  
A combination of shear and dynamic compression leads to mechanically induced chondrogenesis of human mesenchymal stem cells.  
*Eur Cell Mater* 2011;22:214-25 (IF 9.650)

Schiuma D, Brianza S, Tami AE.  
Development of a novel method for surgical implant design optimization through noninvasive assessment of local bone properties.  
*Med Eng Phys* 2011;33:256-62 (IF 1.906)

Schmutz B, Wullschlegler ME, Noser H, Barry M, Meek J, Schutz MA.  
Fit optimisation of a distal medial tibia plate.  
*Comput Methods Biomech Biomed Engin* 2011;14:359-64 (IF1.573)

Sermon A, Boner V, Boger A, Schwieger K, Boonen S, Broos PL, Richards RG, Windolf M.  
Potential of Polymethylmethacrylate Cement-Augmented Helical Proximal Femoral Nail Antirotation Blades to Improve Implant Stability-A Biomechanical Investigation in Human Cadaveric Femoral Heads.  
*J Trauma* 2011; epub July 15 (IF 3.129)

Sermon A, Boner V, Schwieger K, Boger A, Boonen S, Broos P, Richards RG, Windolf M.  
Biomechanical evaluation of bone-cement augmented Proximal Femoral Nail Antirotation blades in a polyurethane foam model with low density.  
*Clin Biomech (Bristol, Avon)* 2011; epub Aug 06 (IF 2.036)

Stoyanov J, Gantenbein-Ritter B, Bertolo A, Aebli N, Baur M, Alini M, Grad S.  
Role of hypoxia and growth and differentiation factor-5 on differentiation of human mesenchymal stem cells towards intervertebral nucleus pulposus-like cells.  
*Eur Cell Mater* 2011;21:533-47 (IF 9.650)



Verrier S, Peroglio M, Voisard C, Lechmann B, Alini M.  
The osteogenic differentiation of human osteoprogenitor cells on Anodic-Plasma-Chemical treated Ti6Al7Nb.

Biomaterials 2011;32:672-680 (IF 7.882)

Verrier S, Hughes L, Alves A, Peroglio M, Alini M, Boger A.

Evaluation of the *in vitro* cell-material interactions and *in vivo* osteo-integration of a spinal acrylic bone cement.

Eur Spine J 2011; epub Aug 03 (IF 1.994)

Wähnert D, Lenz M, Schlegel U, Perren S, Windolf M.

Cerclage Handling for Improved Fracture Treatment. A Biomechanical Study on the Twisting Procedure.

Acta Chir Orthop Traumatol Cech 2011;78:208-14 (IF 1.620)

Wähnert D, Windolf M, Brianza S, Rothstock S, Radtke R, Brighenti V, Schwieger K.

A comparison of parallel and diverging screw angles in the stability of locked plate constructs.

J Bone Joint Surg Br 2011;93:1259-64 (IF 2.351)

Wohlrab D, Radetzki F, Noser H, Mendel T.

Cup positioning in total hip arthroplasty: spatial alignment of the acetabular entry plane.

Arch Orthop Trauma Surg 2011; epub 2011 Aug 28 (IF 1.196)

### ARI Patents 2011

A method and device for computer assisted surgery

- First Application: PCT - CH2011/000299 filed 2011-12-15
- Case: 2799
- Developer / Inventors: Markus Windolf, Christoph Nötzli

### Books and bookchapters

Stoddart MJ (Ed.).

Mammalian Cell Viability. Methods and Protocols.

Methods in Molecular Biology Vol 740. New York, Humana Press / Springer 2011

Biggs MJ, Richards RG, Dalby MJ.

Using immuno-scanning electron microscopy for the observation of focal adhesion-substratum interactions at the nano- and microscale in S-phase cells.

In: Haycock JW (Ed.). 3D Cell Culture. Methods and Protocols.

Methods in Molecular Biology Vol 695, pp 53-60. Clifton NJ, Humana Press 2011

Czekanska EM.

Assessment of cell proliferation with resazurin-based fluorescent dye.

In: Stoddart MJ (Ed.). Mammalian cell viability. Methods and Protocols.

Methods in Molecular Biology Vol 740, pp 27-32. New York, Humana Press 2011

Egli RJ, Wernike E, Grad S, Luginbuhl R.

Physiological cartilage tissue engineering effect of oxygen and biomechanics.

In: Jeon KW (Ed.). International Review of Cell and Molecular Biology,

Vol. 289 pp. 37-87. Burlington, Elsevier / Academic Press 2011

Gantenbein-Ritter B, Sprecher CM, Chan S, Illien-Junger S, Grad S.

Confocal imaging protocols for live/dead staining in three-dimensional carriers.

In: Stoddart MJ (Ed.). Mammalian cell viability. Methods and Protocols.

Methods in Molecular Biology Vol 740, pp 127-40. New York, Humana Press 2011

Hayes JS, Czekanska EM, Richards RG.

The Cell-Surface Interaction.

In: Advances in biochemical engineering/biotechnology. Berlin, Springer 2011 Oct 8 epub

Jahn K, Stoddart MJ.

Viability assessment of osteocytes using histological lactate dehydrogenase activity staining on human cancellous bone sections.

In: Stoddart MJ (Ed.). Mammalian cell viability. Methods and Protocols.

Methods in Molecular Biology Vol 740, pp 141-148. New York, Humana Press 2011

Moriarty TF, Poulsson AH, Rochford ET, Richards RG.

Bacterial adhesion and biomaterial surfaces.

In: Ducheyne P, Healy KE, Hutmacher DW, Grainger DW, Kirkpatrick CJ (Eds). Comprehensive Biomaterials, Vol 4: pp 75-100. Elsevier; 2011

Stoddart MJ.

Cell viability assays: introduction.

In: Stoddart MJ (Ed.). Mammalian cell viability. Methods and Protocols.

Methods in Molecular Biology Vol 740, pp 1-6. New York, Humana Press 2011

Stoddart MJ.

WST-8 Analysis of Cell Viability During Osteogenesis of Human Mesenchymal Stem Cells.

In: Stoddart MJ (Ed.). Mammalian cell viability. Methods and Protocols.

Methods in Molecular Biology Vol 740, pp 21-25. New York, Humana Press 2011

Verrier S, Zoladek A, Notingher I.

Raman Micro-Spectroscopy as a Non-invasive Cell Viability Test.

In: Stoddart MJ (Ed.). Mammalian cell viability. Methods and Protocols.

Methods in Molecular Biology Vol 740, pp 179-189. New York, Humana Press 2011

Verrier S, Gough JE, Boccaccini AR.

Bioactive glass containing composites for bone and musculoskeletal tissue engineering scaffolds.

In: Ylänen HO (Ed.). Bioactive glasses. Materials, properties and applications, pp 162-88. Woodhead Publishing 2011;

### Abstracts published in journals

Braun T, Lepper J, Lezuo P, Schett G, Zwerina J.

MAPK-activated protein kinase-2 regulates physiological bone turnover.

Ann Rheum Dis 2011, 70: A21-A22

EWRR 2011, Amsterdam

Bruderer M, Stoddart MJ, Alini M.

Characterization of osteoprogenitors functionally isolated from human mesenchymal stem cells by a runx2 reporter adenovirus. J Miner Stoffwechs 2011;18 Suppl 2:24.

SBMS 2011, Bern

Duttenhoefer F, Lara de Freitas R, Loibl M, Richards RG, Alini M, Verrier S.

*In vitro* prevascularisation of a 3D scaffold using autologous endothelial progenitor- and mesenchymal stem cells.

J Miner Stoffwechs 2011;18 Suppl 2:24-5.

SBMS 2011, Bern

Duttenhoefer F, Lara de Freitas R, Loibl M, Richards RG, Alini M, Verrier S.

Endothelial Progenitor Cells (CD34+) and Bone Marrow Mesenchymal Stem Cells co-culture promotes 3D scaffold neovascularization.

Histol Histopathol 2011; 26 Suppl 1

TERMIS 2011, Granada

Gimeno-Fabra M, Peroglio M, Eglin D, Alini M, Perry CC.

Silica improves cell viability and modulates growth factor release in platelet-rich plasma-alginate hydrogels.

J Miner Stoffwechs 2011;18 Suppl 2:25.

SBMS 2011, Bern

Lara de Freitas R, Duttenehoefer F, Loibl M, Richards RG, Alini M, Verrier S.  
Osteogenic potential of total BMC (bone marrow mononucleated cells) versus EPC-depleted-BMC fraction (endothelial progenitor cells).  
J Miner Stoffwechs 2011;18 Suppl 2:25-6.  
SBMS 2011, Bern

Lara de Freitas R, Duttenehoefer F, Loibl M, Richards RG, Alini M, Verrier S.  
The EPC (Endothelial Progenitor Cells) fraction contained in the BMC (Bone marrow Monocyte Cell) population impairs the osteogenic differentiation.  
Histol Histopathol 2011; 26 Suppl 1  
TERMIS 2011, Granada

Li Z, Yao SJ, Alini M, Stoddart MJ.  
The role of retinoic acid receptor inhibitor LE135 on osteochondral differentiation of human bone marrow mesenchymal stem cells.  
Histol Histopathol 2011; 26 Suppl 1  
TERMIS 2011, Granada

Peroglio M, Eglin D, Sprecher CM, Illien-Jünger S, Grad S, Alini M.  
Thermoreversible Hyaluronan-based hydrogels for nucleus pulposus tissue engineering.  
Histol Histopathol 2011; 26 Suppl 1  
TERMIS 2011, Granada

Popp AW, Brianza S, Lippuner K, Tami AE, Richards RG, Windolf M, Schiuma D.  
Areal bone mineral density at distal tibia predicts micro structure assessed by HR-PQCT. J Miner Stoffwechs 2011;18 Suppl 2:22  
SBMS 2011, Bern

Seelbach R, Fransen P, Peroglio M, Royo M, Eglin D, Mata A, Alini M.  
Developing an injectable biofunctional, biomimetic hydrogel scaffold for regenerative medicine applications.  
Histol Histopathol 2011; 26 Suppl 1  
TERMIS 2011, Granada

### Conference proceedings

Brady M, Poulsson AH, Wilson J, Eglin D, Richards RG, Jarman-Smith M.  
Mechanical properties and bioactivity of PEEK-OPTIMA®/Hydroxyapatite compounds.  
2011. SFB.

Bruderer M, Stoddart MJ, Vogel V, Alini M.  
Characterization of osteoprogenitors functionally isolated from human mesenchymal stem cells by a RUNX2 reporter adenovirus.  
2011. WCRM.

Bruderer M, Stoddart MJ, Alini M.  
Functional identification and isolation of osteoprogenitors from human mesenchymal stem cells using a Runx2 reporter adenovirus.  
2011. SSCN.

Bruderer M, Stoddart MJ, Alini M.  
Identification and isolation of committed osteogenic progenitors from a heterogeneous population of mesenchymal stem cells using a Runx2 reporter adenovirus.  
2011. ORS.

Czekanska E, Stoddart M, Hayes JS, Ralphs J, Richards RG.  
Evaluation of osteoblast cell models used in orthopaedic related research.  
2011. ORS.

D'Este M, Borget P, Daculsi G, Alini M, Eglin D.  
A composite calcium phosphate / thermo-responsive hydrogel for bone tissue engineering.  
2011. Biohydrogels.

Duttenhoefer F, Sauerbier S, Benneker L, Richards RG, Alini M, Verrier S.  
Pre-vascularization of 3D scaffolds for tissue engineering application in critical size bone defects.  
2011. ADT.

Erdöhelyi B, Kamer L.  
Value of virtual fracture reduction exemplified in CT data of pilon fractures.  
2011. CARS.

Fliri L, Schroeder J, Richards RG, Windolf M.  
A novel technique for simplified distal interlocking of IM nails to reduce radiation exposure.  
2011. DGU / DKOU.

Fliri L, Wähnert D, Sermon A, Schmoelz W, Blauth M, Boger A, Windolf M.  
V-shaped cement augmentation of the proximal femur to prevent secondary hip fractures.  
2011. ESTES.

Gautier E, Schlegel U, Gueorguiev B, Matthys R, Alajmo G.  
Plunging when Drilling: Effect of Using Blunt Drill-bits.  
2011. SGOT, **Award: 2nd price for poster presentation.**

Glärner M, Fliri L, Alini M, Windolf M, Eglin D.  
*In vitro* degradation of poly(ester-urethane) scaffolds for bone repair.  
2011. FBPS.

Glärner M, Fliri L, Windolf M, Alini M, Eglin D.  
Poly(ester-urethane) foams for bone repair. An *in vitro* degradation study.  
2011. SSB.

Grad S, Rutges J, Cremers LB, Buttner A, Milz S, Alini M.  
Differential gene expression of human nucleus pulposus cells and articular chondrocytes: What defines the intervertebral disc cell phenotype?  
2011. ORS.

Grad S, Stoddart MJ, Lezuo P, Alini M.  
Mimicking the physiological environment to engineer and study articular cartilage and intervertebral disc.  
2011. Aegean Conferences Series, Vol 55: 4th. International Conference on TE.

Horn N, Lutton C, Eglin D, Richards RG, Moriarty TF.  
Antibacterial activity of antibiotic loaded thermo-responsive hyaluronan hydrogel.  
2011. ESB.

Jähn K, Richards RG, Archer C, Stoddart MJ.  
Pellet culture model for human primary osteoblasts.  
2011. ORS.

Klos K, Gras F, Windolf M, Gueorguiev B, Hofmann GO, Muckley T.  
Verschiedene Verfahren der Knochendichtemessung am Rückfuß und sich daraus ergebende Konsequenzen: Eine biomechanische Studie  
2011. VLOU Weimar.

Klos K, Rausch S, Windolf M, Gueorguiev B, Hofmann GO, Muckley T.  
Evaluierung einer polyaxialen winkelstabilen volaren Platte an einem C-Frakturmodell am distalen Radius. Eine biomechanische Studie.  
2011. DGfB.

Klos K, Rausch S, Gras F, Windolf M, Hofmann GO, Muckley T.  
Evaluation of a variable-angle angle-stable volar plate in a distal radius C-fracture model - A biomechanical study.  
2011. ESTES.

Krause F, Blatter S, Wähnert D, Windolf M, Weber M.  
Hindfoot joint pressure in acute and recurrent sprains.  
2011. AOFAS.

Lambert S, Kamer L, Südkamp NP.  
Clavicular anatomy: A serial study using CT data and 3D statistical analysis.  
2011. BSES.

Lenz M, Windolf M, Rothstock S, Muckley T, Hofmann GO, Richards RG, Schwieger K, Gueorguiev B.  
Liefen neue Plattendesigns eine Lösungsoption bei periprothetischen Femurfrakturen - eine biomechanische Studie zum Vergleich zweier Techniken.  
2011. VLOU Jena, **Award: 3rd price for best oral presentation.**

Lenz M, Windolf M, Rothstock S, Muckley T, Hofmann GO, Richards RG, Schwieger K, Gueorguiev B.  
Comparison of two techniques for proximal fixation of periprosthetic fractures. A biomechanical study.  
2011. OTA.

Lenz M, Windolf M, Rothstock S, Hofmann GO, Schwieger K, Gueorguiev B. Biomechanische Eigenschaften der Locking Attachment Plate in der proximalen Fixation periprothetischer Femurfrakturen.  
2011. DGU / DKOU.

Li Z, Yao SJ, Alini M, Stoddart MJ.  
The role of retinoic acid receptor inhibitor LE135 on osteochondral differentiation of human bone marrow mesenchymal stem cells.  
2011. SSCN.

Mendel T, Radetzki F, Noser H, Arlt S, Marintschev I, Hofmann GO.  
Visualisation sicherer Knochenregionen am Beckenring - Neue Erkenntnisse aus 3-D radiomorphometrischen Untersuchungen.  
2012. VLOU

Neumann AJ, Alini M, Stoddart MJ.  
Enhanced gene delivery using adenoviral vectors.  
2011. ORS.

Pattappa G, Illien-Jünger S, Peroglio M, Stoddart M, Sakai D, Mochida J, Grad S, Alini M.  
Regenerative Strategies for the intervertebral disc: Mesenchymal stem cell (MSC) homing.  
2011. SRS Spine Research Symposium.

Pattappa G, Illien-Jünger S, Peroglio M, Grad S, Alini M.  
Mesenchymal stem cell homing is influenced by soluble mediators from stressed intervertebral discs with or without end-plate.  
2011. ISSLS.

Peroglio M, Eglin D, Sprecher CM, Illien-Jünger S, Grad S, Alini M.  
Viability, Glycosaminoglycan Synthesis and Phenotype of Nucleus Pulposus Cells in Thermoreversible Hydrogel.  
2011. ESB.

Peroglio M, Eglin D, Grad S, Alini M.  
Assessment of nucleus pulposus cell phenotype cultured in thermoreversible hyaluronan-based hydrogels.  
2011. ORS.

Peroglio M, Eglin D, Alini M, Grad S.  
Thermoreversible hyaluronan-based hydrogels for cartilage repair.  
2011. ORS.

Popp AW, Windolf M, Lippuner K, Brianza S, Tami AE, Richards RG, Schiuma D.  
Areal bone mineral density and DXA derived geometrical parameters at the tibial diaphysis predict 3D indexes of bone strength assessed by HR-pQCT.  
2011. ASBMR.

Potapova I, Richards RG, Moriarty TF.  
Bacteriocins as Gram-specific infection probes.  
2011. WMICWorld Molecular Imaging Congress.

Poulsso AH, Richards RG.  
Improving osteoblast cytocompatibility of PEEK by a stable oxygen plasma surface modification.  
2011. ESB.

Poulsso AH, Richards RG.  
Stable oxygen plasma surface modification of PEEK to improve osteoblast cytocompatibility.  
2011. SFB.

Poulsso AH, Richards RG.  
Improving human primary osteoblast interactions to PEEK by surface modification.  
2011. ORS.

Rochford ET, Moriarty TF, Richards RG, Poulsso AH.  
*In vitro* bacterial adhesion to PEEK tailored for osseointegration by surface modification.  
2011. SSB.

Rochford ET, Moriarty TF, Richards RG, Poulsso AH.  
*In vitro* bacterial interactions with surface modified PEEK.  
2011. Stevens Conference on Bacteria-Material Interactions.

Rochford ET, Moriarty TF, Richards RG, Poulsso AH.  
The effect of surface modifying PEEK to improve osseointegration on bacterial adhesion *in vitro* .  
2011. ESB.

Rochford ET, Subbiahdoss G, Moriarty TF, Poulsso AH, van der Mei HC, Busscher HJ, Richards RG.  
Co-culture adhesion of bacteria and osteoblasts to oxygen plasma treated PEEK.  
2011. ORS.

Rochford ET, Subbiahdoss G, Moriarty TF, Poulsso AH, van der Mei HC, Busscher HJ, Richards RG.  
Plasma surface modification of PEEK - Effects on bacterial adhesion and co-culture with osteoblasts *in vitro* .  
2011. SFB.

Rothstock S, Schiuma D, Argarwal Y, Heldstab T, Tami A, Brianza S.  
Variable angle stable implant accounting for local bone quality.  
2011. DGfB.

Schätti O, Grad S, Alini M, Goldhahn J, Stoddart MJ.  
Shear is a requirement for mechanically induced chondrogenesis of human bone marrow derived stem cells.  
2011. ISSCR.

Schiuma D, Rothstock S, Tami AE, Brianza S.  
A novel method to improve the locking screws purchase in the humeral head.  
2011. ISTA.

Schiuma D, Rothstock S, Tami AE, Brianza S.  
Surgical implant design optimization based on local bone properties: finite element analysis of the potential benefits on bone strain.  
2011. EMPEC

Schroeder J, Fliri L, Liebergall M, Richards RG, Windolf M.  
A novel technique for simplified distal interlocking of intra medullar nails to reduce radiation exposure.  
2011. CAOS.

Schroeder J, Grad S, Verrier S, Peroglio M, Kaplan L, Hasharoni A, Barzilay Y, Liebergall M, Richards RG, Alini M.  
Proliferation of annulus fibrosus cells in platelet rich plasma -a natural 3D scaffold: an *in vitro* study.  
2011. ISSLS.

Stephan H, Klos K, Rausch S, Gueorguiev B, Windolf M, Hofmann GO, Mückley T.  
Ist polyaxial (winkel)stabil? - biomechanische Aspekte einer polyaxial winkelstabilen volaren Radiusplatte.  
2011. VLOU Jena.

Stoddart MJ.

From the laboratory to the Ski Slope: Winter Sport- too great a load for cartilage?  
2011. International Knee Update.

Stoyanov J, Gantenbein-Ritter B, Aebli N, Baur M, Alini M, Grad S.

Hypoxia enhances differentiation of mesenchymal stem cells towards intervertebral disc-like cells.  
2011. SSCN.

Stoyanov J, Gantenbein-Ritter B, Alini M, Grad S.

Differentiation of mesenchymal stem cells: Evaluation of different stimuli and of new markers to distinguish chondrogenic from intervertebral disc-like differentiation  
2011. GSC.

Stoyanov JV, Gantenbein-Ritter B, Aebli N, Baur M, Alini M, Grad S.

Role of hypoxia, GDF5 and TGF-beta on differentiation of human mesenchymal stem cells towards intervertebral nucleus pulposus-like cells.  
2011. ORS.

Sukarto A, Flynn FA, Amsden BG. Co-delivery of Growth Factor-Loaded Microspheres and Human Adipose-Derived Stem Cells in A Gel Matrix ForCartilage Repair.

2011. ESB.

## Dissertations

Viehöfer AF. Die molekulare Zusammensetzung der extrazellulären Matrix des Lig. iliolumbale des Menschen. 2011. Ludwig-Maximilians Universität München (Dr med / Milz S).

Oliver R. Schätti: Tissue engineering of articular cartilage: Effect of shear on stem cell fate under loading conditions (Stoddart M, Grad S, Goldhahn J, Müller R) Master of Science ETH in Human Movement Sciences (MSc ETH HMS)

Nadine Wismer: Characterization of biodegradable electrospun scaffolds for annulus fibrosus tissue engineering: biochemical and biomechanical properties (Grad S, Eglin D, Ferguson SJ, Müller R) Master of Science ETH in Human Movement Sciences (MSc ETH HMS)

Britta Striegl: Culture of human mesenchymal stem cells in 3D polyurethane-hyaluronan hydrogel composites (Peroglio M, Grad S, Graf-Hausner U) Bachelor of Science (BSc) ZHAW

David Larroze: Réticulation d'hydrogels biocompatibles par des particules magnétiques (Coradin T, Eglin D, Bregiroux D) Master of Science (MSc Polytech Paris UPMC)

